

Your Global Automation Partner

TURCK

TN...-Q...L...-H1147 UHF Read/Write Heads

Instructions for Use



Contents

1	About These Instructions	5
1.1	Target groups.....	5
1.2	Explanation of symbols used	5
1.3	Other documents	5
1.4	Naming convention	5
1.5	Feedback about these instructions.....	5
2	Notes on the Product	6
2.1	Product identification.....	6
2.2	Scope of delivery	6
2.3	Legal requirements	7
2.4	Manufacturer and service	7
3	For Your Safety.....	8
3.1	Intended use.....	8
3.2	Obvious misuse.....	8
3.3	General safety notes	9
4	Product Description	10
4.1	Device overview	10
4.1.1	Display elements.....	10
4.2	Properties and features.....	10
4.3	Operating principle.....	11
4.4	Functions and operating modes	12
4.4.1	Operating frequency	12
4.4.2	Combination of UHF read/write heads and tags.....	12
4.5	Technical accessories.....	13
5	Installing.....	14
5.1	Mounting plate fixing.....	15
5.2	Mast and tube mounting	16
5.3	With the RH-Q240L280/Q280L640 arm bracket.....	17
6	Connection.....	18
6.1	Wiring diagrams	18
7	Commissioning	19
7.1	Connecting read/write heads with the PC.....	19
7.1.1	Connecting the read/write head with a PC via the RFID interface	19
7.1.2	Connecting the read/write head with a PC via the interface converter	20
7.1.3	Creating a project in PACTware.....	21
7.2	Parameterizing read/write heads with the DTM	26
7.2.1	Starting the extended read/write head parameter setting	27
7.2.2	DTM main menu – overview.....	28
7.2.3	Choosing the access level	29
7.2.4	Calculating radiated power.....	30
7.2.5	Switching on Presence sensing mode	31
7.2.6	Transferring the RSSI value – communication	32
7.2.7	Setting the air interface parameters – EPC Class 1 Gen 2.....	33
7.2.8	Error Handling – selectable parameters	33
7.2.9	Event Handling – selectable parameters.....	33

7.2.10	Setting the RSSI filter – Post read filter.....	34
7.2.11	Setting LED indication – Signaling	35
7.3	Testing the read/write head.....	36
7.3.1	Starting the RFID Test.....	36
7.3.2	Start window – overview.....	37
7.3.3	RFID Test – main menu	38
7.3.4	RFID Test – Basic test window	39
7.3.5	RFID Test – Tag actions window	40
7.3.6	RFID Test – Logger window	42
7.3.7	RFID Test – Reader Status window	43
7.3.8	HF diagnosis window	43
7.4	Querying device information with the DTM	44
8	Operation	46
8.1	LED indications	46
9	Troubleshooting	47
9.1	Rectifying errors	48
10	Maintenance.....	50
11	Repair.....	50
11.1	Returning devices.....	50
12	Disposal.....	50
13	Technical Data.....	51
13.1	Technical data – TN865... ..	51
13.2	Technical data – TN902... ..	52
13.3	Technical data – TN840/920... ..	53
13.4	Technical data – TN917... ..	54
13.5	Technical data – TN866... ..	55
13.6	Technical data – TN902/915... ..	56
13.7	Technical data – TN920... ..	57
13.8	Technical data – TN921... ..	58
14	Appendix: Conformity Declarations and Approvals.....	59
14.1	EU Declaration of Conformity	59
14.2	FCC/IC digital device limitations – TN902-Q120L130-H1147	59
14.3	FCC/IC digital device limitations – TN902-Q175L200-H1147	60

1 About These Instructions

These operating instructions describe the structure, functions and the use of the product and will help you to operate the product as intended. Read these instructions carefully before using the product. This is to avoid possible damage to persons, property or the device. Retain the instructions for future use during the service life of the product. If the product is passed on, pass on these instructions as well.

1.1 Target groups

These instructions are aimed at qualified personal and must be carefully read by anyone mounting, commissioning, operating, maintaining, dismantling or disposing of the device.

1.2 Explanation of symbols used

The following symbols are used in these instructions:



DANGER

DANGER indicates a dangerous situation with high risk of death or severe injury if not avoided.



WARNING

WARNING indicates a dangerous situation with medium risk of death or severe injury if not avoided.



CAUTION

CAUTION indicates a dangerous situation of medium risk which may result in minor or moderate injury if not avoided.



NOTICE

NOTICE indicates a situation which may lead to property damage if not avoided.



NOTE

NOTE indicates tips, recommendations and useful information on specific actions and facts. The notes simplify your work and help you to avoid additional work.



CALL TO ACTION

This symbol denotes actions that the user must carry out.



RESULTS OF ACTION

This symbol denotes relevant results of actions.

1.3 Other documents

Besides this document the following material can be found on the Internet at www.turck.com:

- Data sheet
- Quick start guide
- Configuration manual
- Startup manuals

1.4 Naming convention

Common synonyms for "data carriers" include "tag", "transponder", and "mobile storage device". Read/write heads are also described as "transceivers" or "readers".

1.5 Feedback about these instructions

We make every effort to ensure that these instructions are as informative and as clear as possible. If you have any suggestions for improving the design or if some information is missing in the document, please send your suggestions to techdoc@turck.com.

2 Notes on the Product

2.1 Product identification

These instructions apply to the following UHF read/write heads:

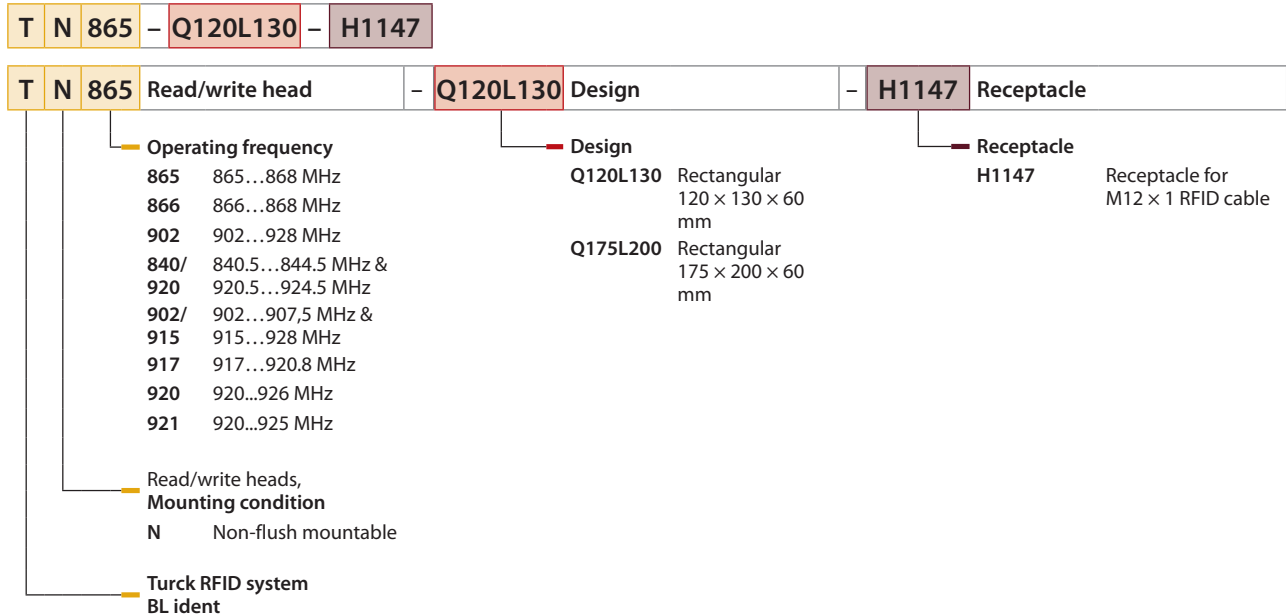

2.2 Scope of delivery

The scope of delivery includes:

- Read/write head
- Quick Start Guide
- Mounting aid incl. mounting bracket and two M6 × 8 screws
- Grounding set
- Four screw covers
- One screw cap M12

2.3 Legal requirements

The devices comply with the following regulations:

Device	Region of use	Regulations
TN865-Q...L...-H1147	e.g. Europe, Turkey, India	<ul style="list-style-type: none"> ■ 2014/30/EU (Electromagnetic compatibility) ■ 2014/35/EU (low voltage) ■ 2014/53/EC (RED Directive) ■ 2011/65/EU (RoHS)
TN902-Q...L...-H1147	USA	FCC Rules Part 15
	Canada	Industry Canada RSS-210
	Mexico	IFETEL, Dictamen (electrical safety)
TN840/920-Q120L130-H1147	China	SRRC
TN917-Q120L130-H1147	Korea	KCC
TN866-Q120L130-H1147	Russia	Import license for wireless devices
TN902/915-Q120L130-H1147	Brazil	ANATEL
TN920-Q120L130-H1147	Australia	ACMA
	New Zealand	RSM
TN921-Q...L...-H1147	Singapore	IDMA



NOTE

Additional certification may be required, depending on the region of use. Tests for other national approvals can be carried out and implemented if necessary.

2.4 Manufacturer and service

Hans Turck GmbH & Co. KG
 Witzlebenstraße 7
 45472 Mülheim an der Ruhr
 Germany

Turck supports you with your projects, from initial analysis to the commissioning of your application. The Turck product database contains software tools for programming, configuration or commissioning, data sheets and CAD files in numerous export formats. You can access the product database at the following address: www.turck.de/products

For further inquiries in Germany contact the Sales and Service Team on:

- Sales: +49 208 4952-380
- Technology: +49 208 4952-390

Outside Germany, please contact your local Turck representative.

3 For Your Safety

The product is designed according to state-of-the-art technology. However, residual risks still exist. Observe the following warnings and safety notices to prevent damage to persons and property. Turck accepts no liability for damage caused by failure to observe these warning and safety notices.

3.1 Intended use

These devices are designed solely for use in industrial areas.

The BL ident read/write heads are used for contactless data exchange with the BL ident tags in the BL ident UHF RFID system. The following table shows the operating frequency of the devices.

Type code	Operating frequency	Region
TN865-...	865...868 MHz	Europe, Turkey, India
TN902-...	902...928 MHz	North America (USA, Canada, Mexico)
TN840/920-...	840.5...844.5 MHz and 920.5...924.5 MHz	China
TN917-...	917...920.8 MHz	Korea
TN866-...	866...868 MHz	Russia
TN902/915-...	902...907.5 MHz and 915...928 MHz	Brazil
TN920-...	920...926 MHz	Australia, New Zealand
TN921-...	920...925 MHz	Singapore

These devices may only be started up under the following conditions:

- The particular frequency range is permissible for the use of UHF-RFID.
- The operating frequency range of the devices is compliant with the permissible UHF RFID range of the region.
- A valid certification and/or approval is available for the region of use.

The devices may only be used as described in these instructions. Any other use is not in accordance with the intended use. Turck accepts no liability for any resulting damage.

3.2 Obvious misuse

- The devices are not suitable for the protection of persons or property and must not be used in safety-related applications.
- The devices must not be used under water.

3.3 General safety notes

- The device only meets the EMC requirements for industrial areas and is not suitable for use in residential areas.
- The device may only be assembled, installed, operated, parameterized and maintained by professionally-trained personnel.
- The device may only be used in accordance with applicable national and international regulations, standards and laws.
- Any extended stay within the area of radiation of the UHF read/write heads may be harmful to health. Observe minimum distances from the actively radiating surface of the UHF read/write head:

Region	Max. permissible total radiant output power	Safety distance
Europe, Russia, China	2 W ERP (according to ETSI)	> 0.24 m
USA, Canada, Brazil, Korea, Australia, New Zealand	4 W EIRP	> 0.30 m
Singapore	0.5 W ERP	> 0.24 m

- The radiation of the UHF read/write heads may have an adverse effect on the operation of electrically controlled medical equipment. Keep an additional distance from active radiation sources up to the maximum transmission distance.

4 Product Description

The UHF read/write heads have a rectangular design (120 × 130 mm or 175 × 200 mm). The devices are rated to degree of protection IP67 and are contained in an aluminum housing with a plastic front. The power supply and data exchange with the controller are implemented via an RFID interface. A 4-pin M12 × 1 connector is provided for connecting to the RFID interface.

4.1 Device overview

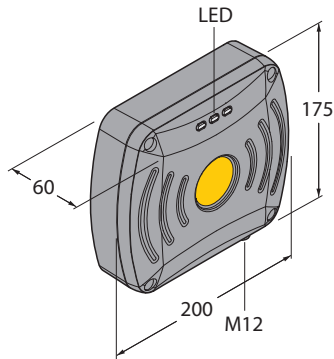

Fig. 1: Dimensions –
TN...-Q175L200-H1147

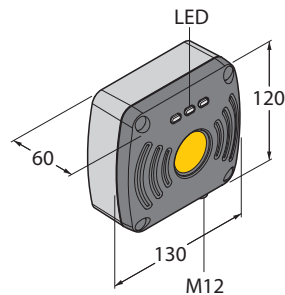

Fig. 2: Dimensions –
TN...-Q120L130-H1147

4.1.1 Display elements

Each device is provided with three adjustable LEDs. An audible alarm can also be set using software tools.

4.2 Properties and features

- Rectangular read/write heads
- Active face front
- Writing and reading of passive UHF tags in single and multitag mode
- Read/write distances up to several meters (depending on ambient conditions, the parameter setting of the read/write head and the selected tag)
- Compact design for mounting in restricted spaces
- Protection class IP67

4.3 Operating principle

The read/write heads are used for contactless data exchange with tags. For this the controller sends commands and data via the interface to the read/write head and receives the corresponding response data from the read/write head. The reading of the IDs of all RFID tags in the read area or the writing of an RFID tag with a specific production date are examples of typical commands. To communicate with the tag, the data of the read/write head is coded and transferred via an electromagnetic field, which at the same time supplies the tags with power.

A read/write head contains a transmitter and a receiver, an interface to the interface and a coupling element (coil and dipole antenna) for communicating with the tag. Electromagnetic wave propagation is used for the transmission between read/write head and tag on devices for the UHF range.

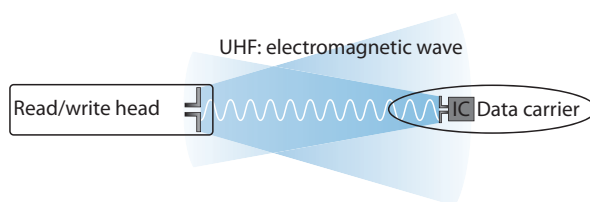

Fig. 3: Operating principle of UHF-RFID

The antenna of the read/write head generates electromagnetic waves. This produces a transmission window as a so-called air interface in which the data exchange with the tag takes place. The size of the transmission window depends on the combination of read/write heads and tags, as well as on the relevant environmental conditions.

Each read/write head can communicate with a number of tags. This requires the read/write head and the tag to operate in the same frequency range. Depending on the power and frequency used, the device ranges vary from a few millimeters up to several meters. The specified maximum read/write distances only represent typical values under laboratory conditions without allowing for the effect of materials. The achievable distances may vary due to component tolerances, the mounting situation in the application, ambient conditions and the effect of materials (particularly metal and liquids).

4.4 Functions and operating modes

The devices enable passive UHF tags to be read or written in single and multitag operation. For this the devices form a transmission zone that varies in size and range according to the tags used and the operating conditions of the application. Refer to the data sheets for the applicable maximum read/write distances. The devices can be fully tested, configured and parameterized from a PC using the specified software tools.

4.4.1 Operating frequency

The Turck UHF system uses nationally specified transmission frequencies for the communication between the tags and read/write heads. These national operating frequencies for UHF are the frequency ranges that are individually specified by the national regulation bodies.

The operating frequency of the devices in the UHF band is for example 865...868 MHz for Europe and 902...928 MHz for the USA. The BL ident read/write heads in the UHF band can therefore only be used in the countries they are intended for and must not be put into operation outside of these regions. As the BL ident UHF tags do not radiate their own radio waves, these are suitable for use worldwide.

Turck offers different tag variants that are specially designed and optimized for national frequency bands in order to achieve as large a communication range as possible. Wide-band multi-range tags for international use are also available as an alternative.

The various Turck read/write heads support the following operating frequencies:

- 865...868 MHz (e.g. for Europe, Turkey and India)
- 866...868 MHz (e.g. for Russia)
- 902...928 MHz (e.g. for USA and Canada)
- 920...925 MHz (e.g. for China and Singapore)
- 902...907.5 MHz and 915...928 MHz (e.g. for Brazil)
- 917...920.8 MHz (e.g. for Korea)

The relevant national specifications for UHF such as frequency range, output and the status of any national regulations can be obtained from the Internet at:
http://www.gs1.org/docs/epcglobal/UHF_Regulations.pdf

For more detailed information please contact the regulation authorities of the country where you wish to use the UHF RFID system.

HF RFID systems can be run parallel to UHF RFID systems in an installation.

4.4.2 Combination of UHF read/write heads and tags

The UHF read/write heads form a transmission zone for which the size depends on the combination of read/write head and tag. The listed maximum read/write distances only represent typical values under laboratory conditions without the effect of materials. The achievable distances may be different due to component tolerances, mounting location in the application, ambient conditions and the effect of materials (particularly metal).

For this reason, the application must be tested in all cases under real conditions (particularly with read and write operations in motion).

4.5 Technical accessories

The following accessories are supplied with the device:

Dimension drawing	Type	Ident-No.	Description
	RH-Q240L280/Q280L640	7030296	Arm bracket for UHF read/write heads

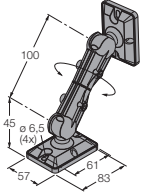

5 Installing

The devices can be mounted in any position.

- ▶ Mount the device with the appropriate fixing accessories.

The minimum distance between two read/write heads using the same frequency depends on the maximum radiant power and the alignment of the antenna.

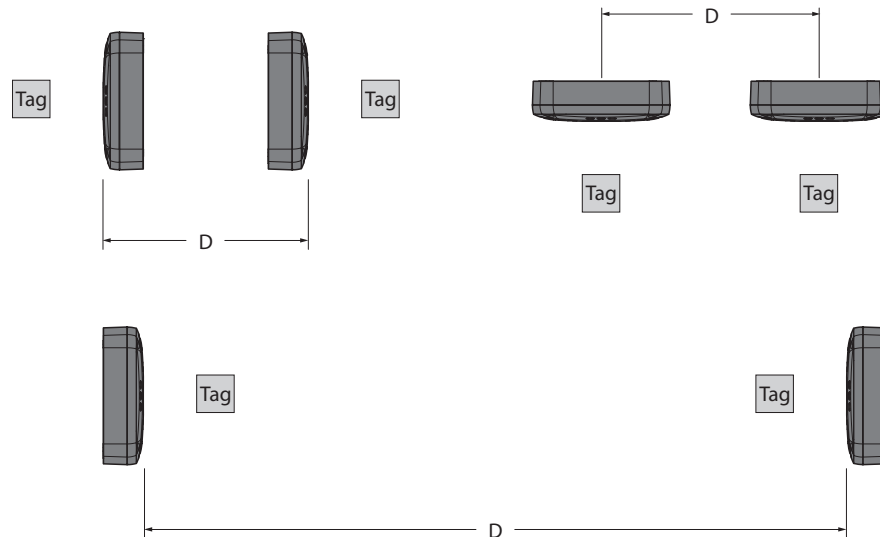

Fig. 4: Antenna alignment

Antenna alignment	Minimum distance D for TN...-Q175L200-H1147 with ERP = 1 W	Minimum distance D for TN...-Q120L130-H1147 with ERP = 0.5 W
Back to back	0.5 m	0.25 m
Side by side	1 m	0.5 m
Front to front	2.5 m	1.25 m



NOTE

The stated values do not take into account the effect of the tags.

5.1 Mounting plate fixing

- ▶ Fasten the device with four M5 × 35 cylinder screws on a pre-drilled mounting plate.

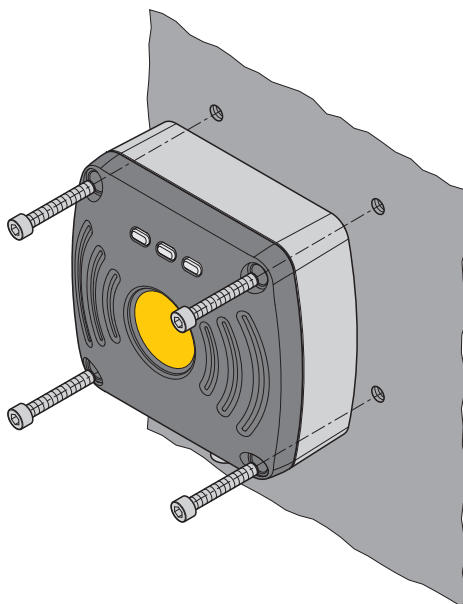

Fig. 5: Screwing the read/write head onto the mounting plate

5.2 Mast and tube mounting

- ▶ Fit the device with the intended mounting aid as shown in the following figure.

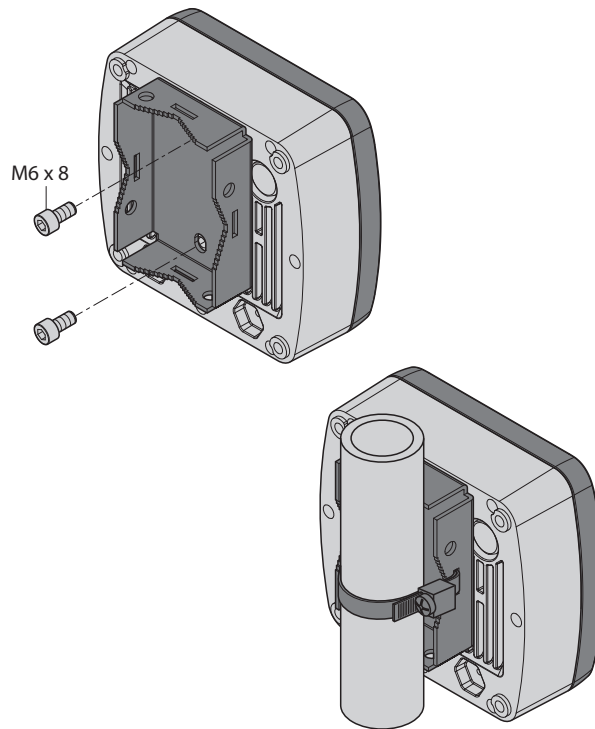

Fig. 6: Mast and tube mounting

5.3 With the RH-Q240L280/Q280L640 arm bracket

The RH-Q240L280/Q280L640 arm bracket (Ident-No. 7030296) is not supplied with the device and must be ordered separately.

- ▶ Secure the read/write head with two M6 × 12 screws on the arm bracket.
- ▶ Mount arm bracket with read/write head at the intended mounting location.

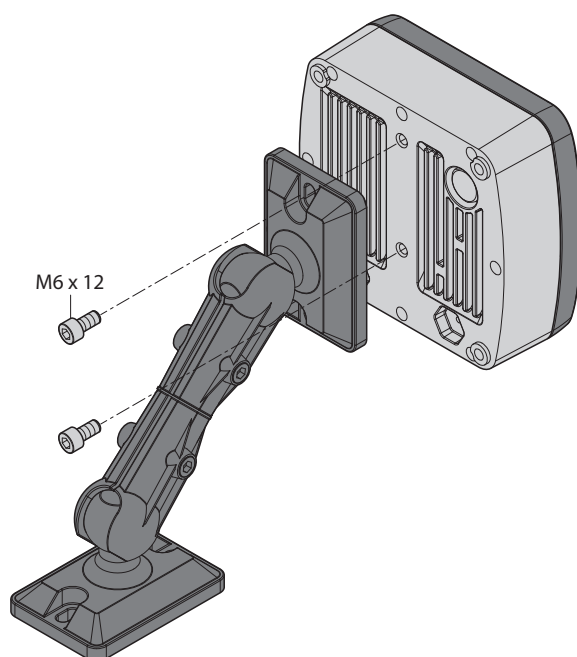

Fig. 7: Mounting the read/write head on the arm bracket

6 Connection



DANGER

Effect on electrically controlled medical devices such as pacemakers
Danger to life due to malfunction or failure of medical equipment

- ▶ Determine and ensure the recommended distances between medical equipment and radiation sources.

- ▶ Connect the device via the M12 plug connector to the RFID interface as shown in the wiring diagrams.

6.1 Wiring diagrams

Connection cables .../S2500

Pin assignment

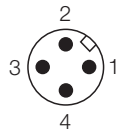

Wiring diagram

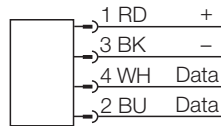

Connection cables .../S2501

Pin assignment

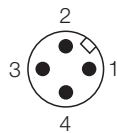

Wiring diagram

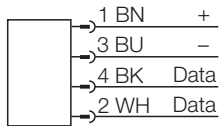

Connection cables .../S2503

Pin assignment

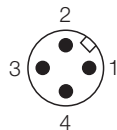

Wiring diagram

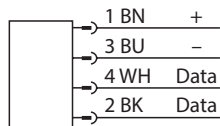

7 Commissioning

The device is operational automatically once the cables are connected and the power supply is switched on.

The read/write heads can be assigned additional parameters via the DTM in the PACTware 5.0 FDT frame application. FDT and DTM can be downloaded free of charge from www.turck.com.

The planning and preparation of an RFID system require different measures, depending on the application. Further information on this is provided in the RFID engineering manual.

7.1 Connecting read/write heads with the PC

In order to carry out extended parameter setting with the DTM, the read/write head must be connected with a PC. The read/write heads can be connected with a PC via a TBEN-RFID interface (e.g. TBEN-S2-2RFID-4DXP) or via the STW-RS485-USB interface converter.

7.1.1 Connecting the read/write head with a PC via the RFID interface

- ▶ Connect the read/write head to the RFID interface converter using an appropriate connection cable (e.g. RK4.5T-2RS4.5T/S2500).
- ▶ Connect the RFID interface via a suitable Ethernet cable to the PC.
- ▶ Connect the RFID interface to a power supply.

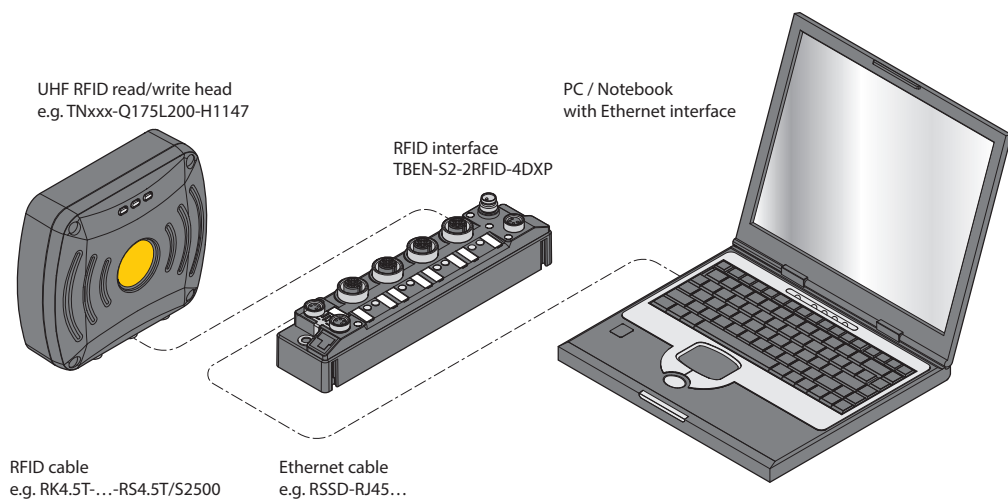

Fig. 8: Connecting the read/write head with a PC via the TBEN-S2-2RFID-4DXP

7.1.2 Connecting the read/write head with a PC via the interface converter

The following accessories are required to connect read/write heads to a PC:

- STW-RS485-USB interface converter (Ident-No. 7030354)
- STW-RS485-USB-PS power supply unit (Ident-No. 7030355)

Accessories are not supplied with the device and must be ordered separately.

- ▶ Connect the read/write head to the interface converter using a suitable connection cable (e.g. RK4.5T-2/S2500) according to the following color coding:

STW-RS485-USB	.../S2500 plug connectors	.../S2501 plug connectors	.../S2503 plug connectors
VCC	Brown (BN)	Brown (BN)	Red (RD)
GND	Blue (BU)	Blue (BU)	Black (BK)
RS485-A	White (WH)	Black (BK)	White (WH)
RS485-B	Black (BK)	White (WH)	Blue (BU)

- ▶ Connect a USB cable to the interface converter (USB1.1 type B).
- ▶ Connect the open end of the USB cable to a free USB port on the PC (USB1.1 type A).
- ▶ Set the switches on the side of the interface converter for the termination to [ON].
- ▶ Connect the interface converter via the STW... power supply unit to a power supply.

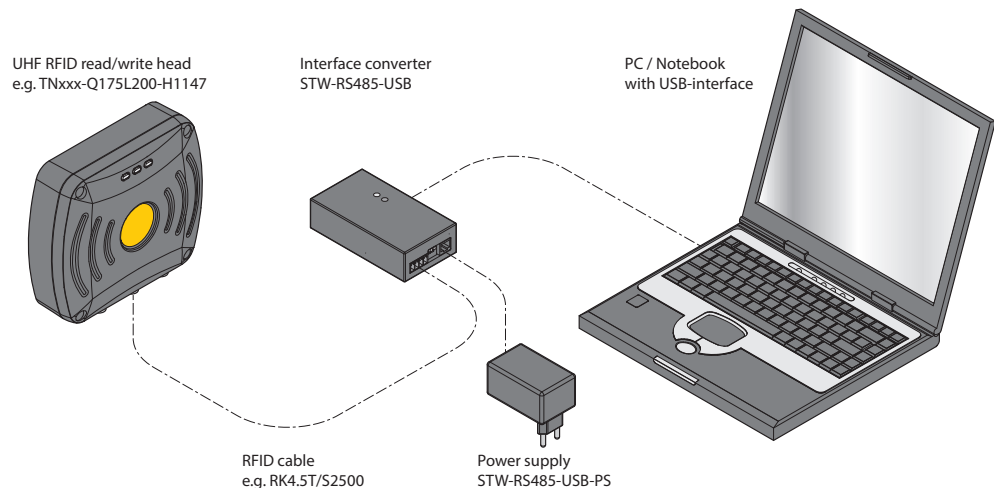

Fig. 9: Connecting the read/write head via the interface converter with a PC

7.1.3 Creating a project in PACTware

- ▶ Open PACTware.
- ▶ Right-click **HOST PC** in the project tree.
- ▶ Click **Add device**.

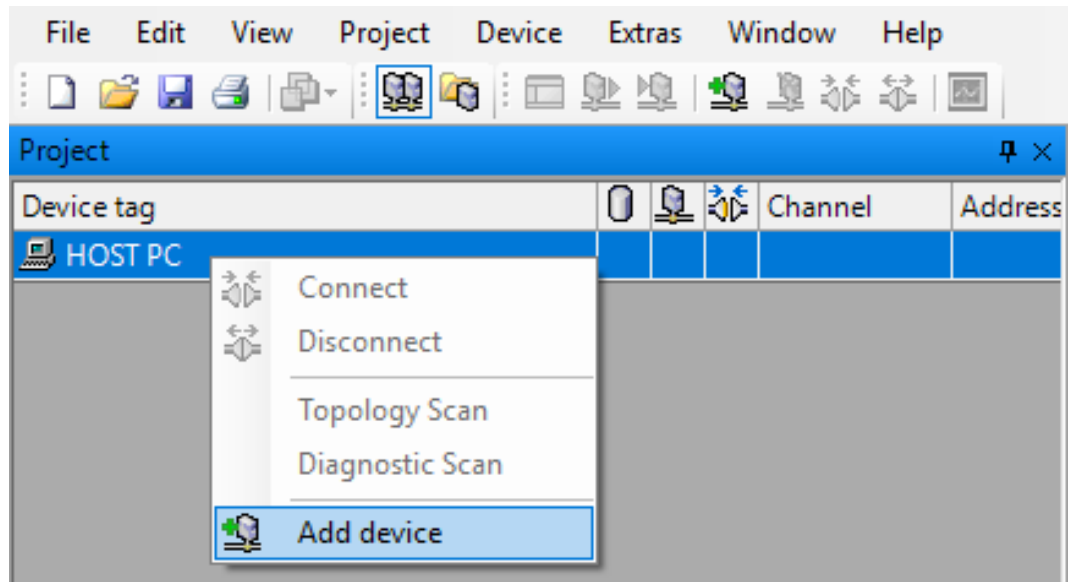

Fig. 10: Adding a device in PACTware



NOTE

The example shows the connection via an interface converter. When using a TBEN-RFID interface, choose the **BL Service Ethernet** option.

- ▶ Example: Select **RS485 RFID** to connect the read/write head to the PC via the RS485 interface.

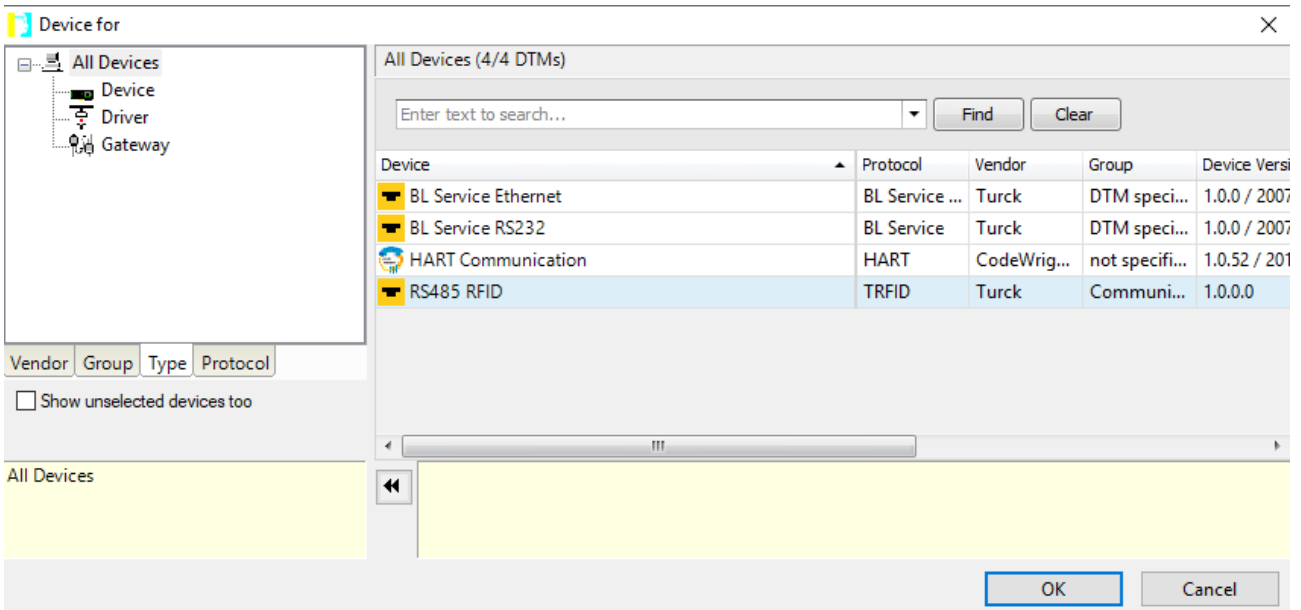

Fig. 11: Example: Selecting RS485 RFID

- ▶ Double-click **RS485 RFID** in the project tree.
- ▶ Select the COM port. The COM port to which the device is connected is shown in the device manager in the control panel of the PC (COM & LPT).
- ▶ Set the transfer rate.

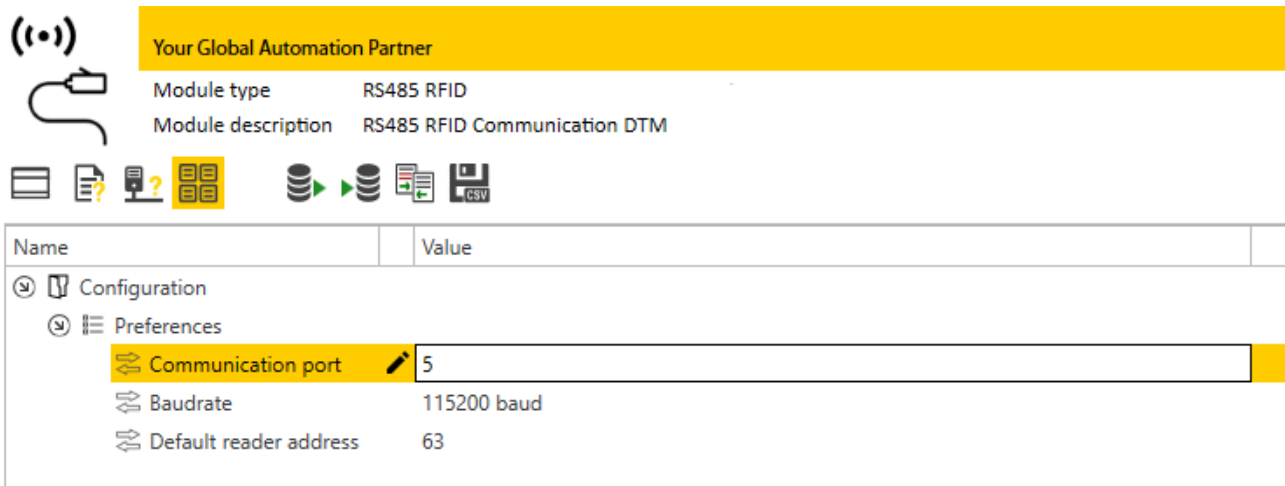

Fig. 12: Setting up the RS485 interface

- ▶ Confirm the changes by clicking **Accept**.

- ▶ Right-click **RS485 RFID** in the project tree.
- ▶ Click **Add device**.

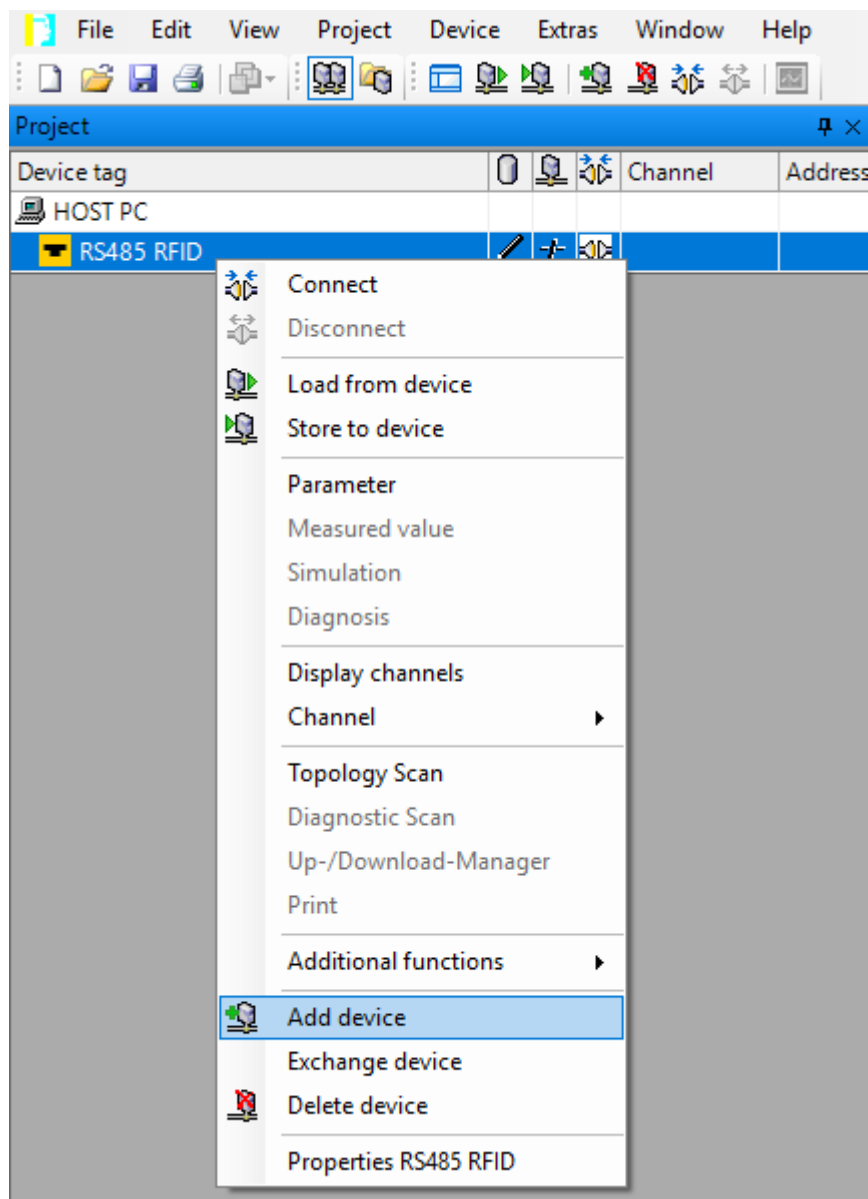

Fig. 13: Adding the device to the RS485 interface

- ▶ Select the connected device (example: TN865-Q175L200-H1147).
- ▶ Confirm the selection with **OK** or double-click the device.

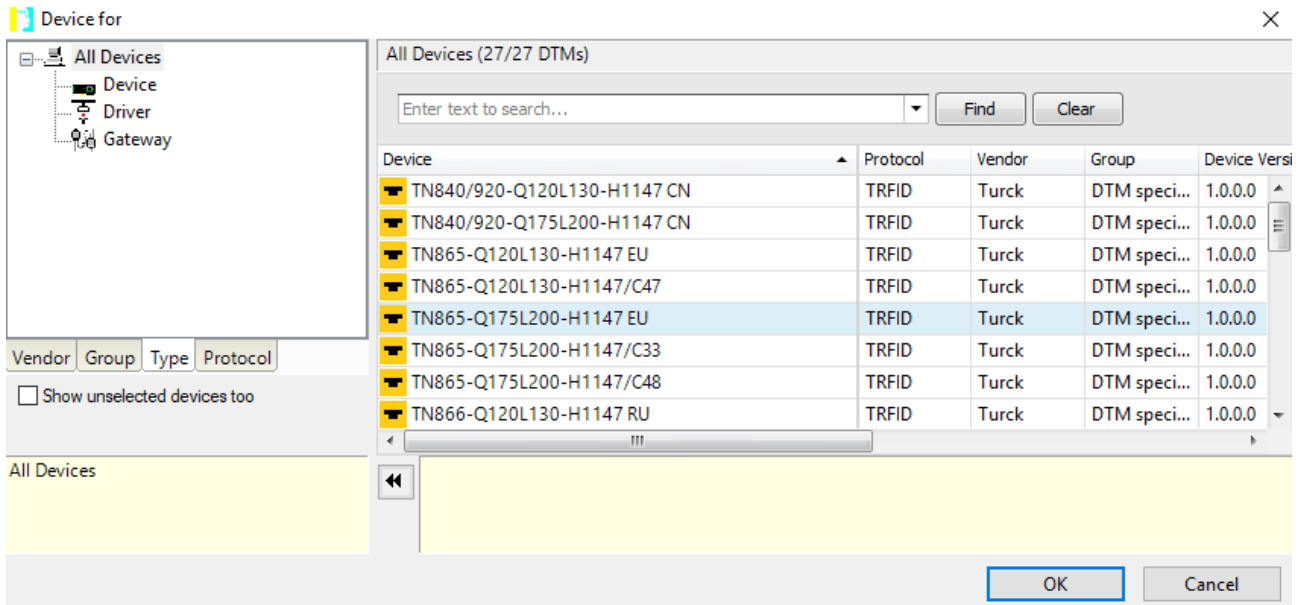

Fig. 14: Select the connected device (example: TN865-Q175L200-H1147)

- ▶ Right-click the device in the project tree.
- ▶ Establish a connection.

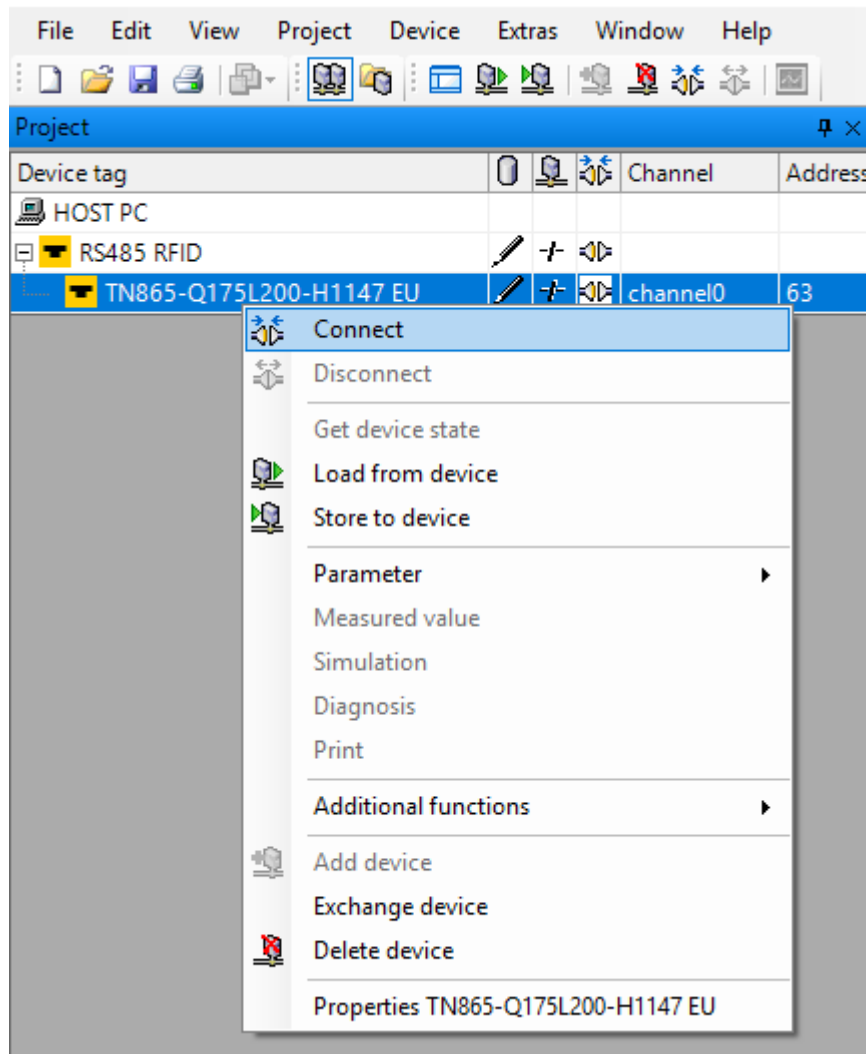

Fig. 15: Establishing a connection

- ⇒ The **RFID Test** and **Parameterization** functions can be started from the project tree at **Additional Functions**.

7.2 Parameterizing read/write heads with the DTM

The UHF settings of the device can be assigned additional parameters via the DTM.

All the required Turck software components can be downloaded via the Turck Software Manager. The Turck Software Manager is available free of charge from www.turck.com.



NOTE

The parameterization function is available in German and English. All parameters are written in the DTM.

The individual read/write heads are available in different variants. When a connection is made to a connected read/write head, the DTM automatically detects the relevant device and deactivates menu items that are not supported. The connection cannot be established if a different variant than set in the project tree is connected.



NOTE

Adjustable parameters are indicated in the DTM with green arrows. Fixed parameters are indicated with gray arrows.

 Enable antenna

 Radiated power unit

Fig. 16: DTM – example of adjustable and fixed parameters

Requirements for extended parameter setting

- PACTware must be installed.
- The DTM for UHF read/write heads must be installed.
- The connection between the read/write head and the PC must be established.
- A project must have been created in PACTware.

7.2.1 Starting the extended read/write head parameter setting

- ▶ Right-click the device.
- ▶ Start the parameter setting: Choose **Parameterization** or **Online parameterization**. The device must be connected to the PC for the **Online parameterization**.

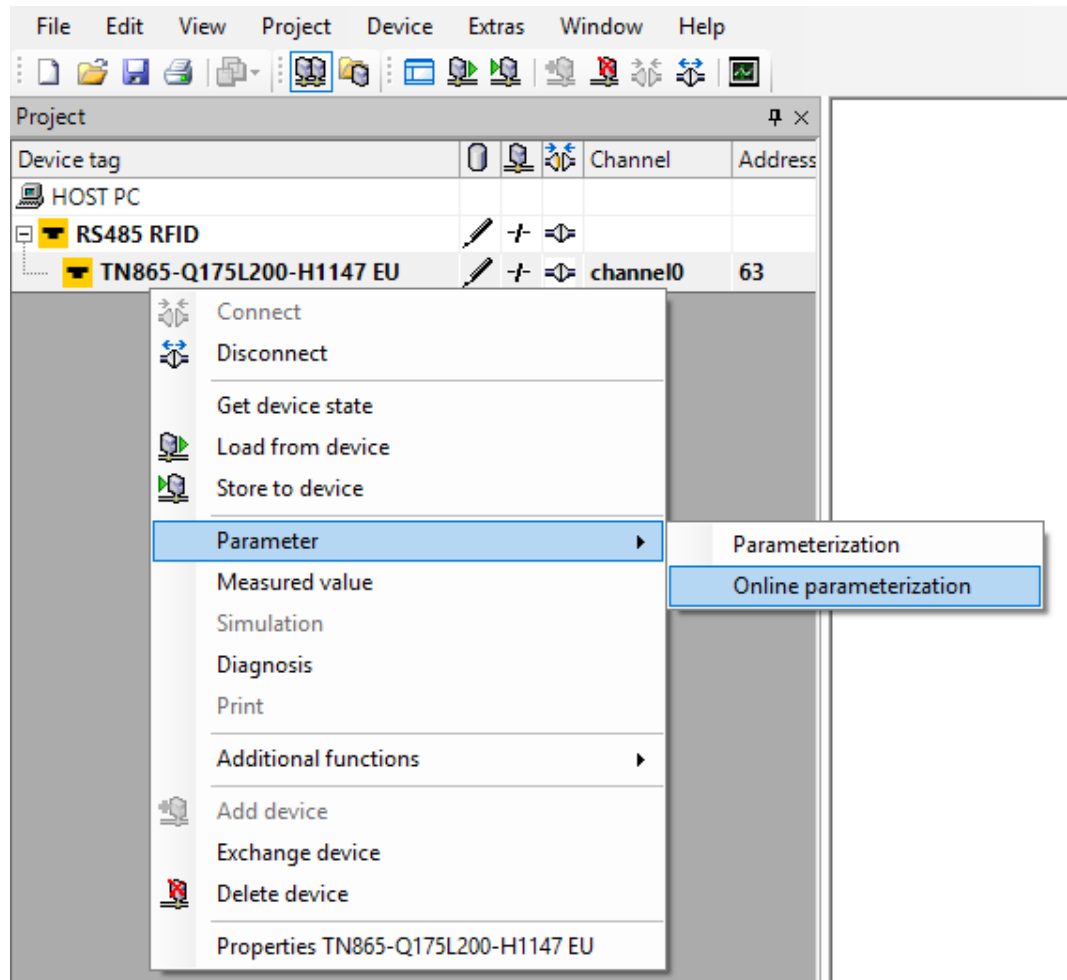

Fig. 17: Example: starting online parameter setting

7.2.2 DTM main menu – overview

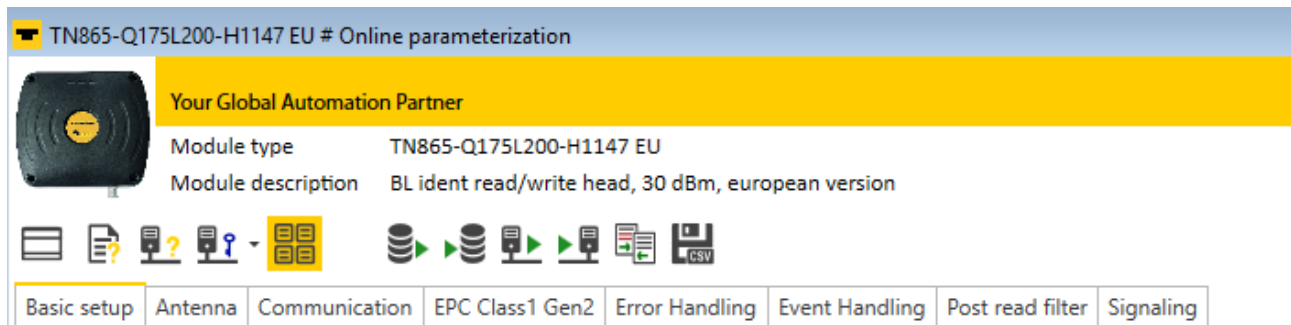

Fig. 18: Online parameter setting – main menu

The main menu provides the following functions:

Icon	Function	Description
	Show and hide information bar	Shows the information bar for the connected device and DTM version at the top of the screen.
	DTM help	Starts the DTM help.
	Device help	Opens the data sheet of the connected read/write head.
	Expert mode ON/OFF	Opens the drop-down menu to select the access level. The following access levels are available: <ul style="list-style-type: none"> Basic (default setting) Advanced Administrator (password-protected)
	Display channel wise	Toggles the view between standard display and channel-wise display.
	Load data from database	Loads previously stored parameters from the database (e.g. an existing project).
	Store data in database	Transfers the current read/write head parameters to the database of the current project.
	Read data from device	Reads the set parameters from the device.
	Transmit data to device	Transfers the set parameters to the device.
	Compare displayed values with database	Compares the values displayed in the DTM with the values saved in the database.
	CSV export current values	Exports the current values from the DTM to a CSV file.

The following setup windows can be opened in tabs via the main menu:

- Basic setup
- Antenna
- Communication
- EPC Class1 Gen2
- Error handling
- Event handling
- Post read filter
- Signaling

7.2.3 Choosing the access level

Three access levels are available for setting the device parameters. Different parameters can be set depending on the access level.



NOTE

Modifications made in the **Administrator** access level can result in serious changes to operation. The **Administrator** access level is therefore only available for Turck service technicians. All relevant settings for the successful parameter setting of an application are available in the **Advanced** access level.

Access level	Description	Initial password
Basic	Basic access for configuration and commissioning	Not required
Advanced	Extended access, e.g. for applications	Not required
Administrator	Administrator access for critical security or wireless settings	Required

The current access level is displayed in the top right screen area of the DTM.

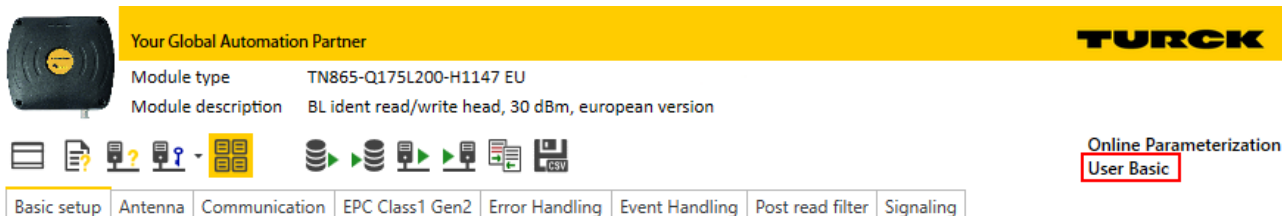

Fig. 19: Display of the access level

7.2.4 Calculating radiated power

The effective radiated power (ERP) is the power that is radiated from an antenna into free space. To make it possible to compare the technical properties of different antenna, the power specifications given are always in relation to a reference antenna.

- EIRP = equivalent isotropic radiated power (reference: isotropic antenna)
- ERP = effective radiated power (reference: with the length of $\lambda/2$)

The radiated power can be stated in watts or in dBm. The following table shows approximate values as a guide for converting between dBm and mW:

dBm	mW	dBm	mW	dBm	mW	dBm	mW
1	1.25	9	8	17	50	25	316
2	1.6	10	10	18	63	26	400
3	2	11	13	19	80	27	500
4	2.5	12	16	20	100	28	630
5	3	13	20	21	125	29	800
6	4	14	25	22	160	30	1000
7	5	15	32	23	200
8	6	16	40	24	250	33	2000

The formula for calculating the exact values is: $\text{dBm} = 10 \times \lg (P/1 \text{ mW})$

- ▶ Set the required radiated power with the slide adjuster in the DTM at **Antenna** → **RF Power** → **Output power**.

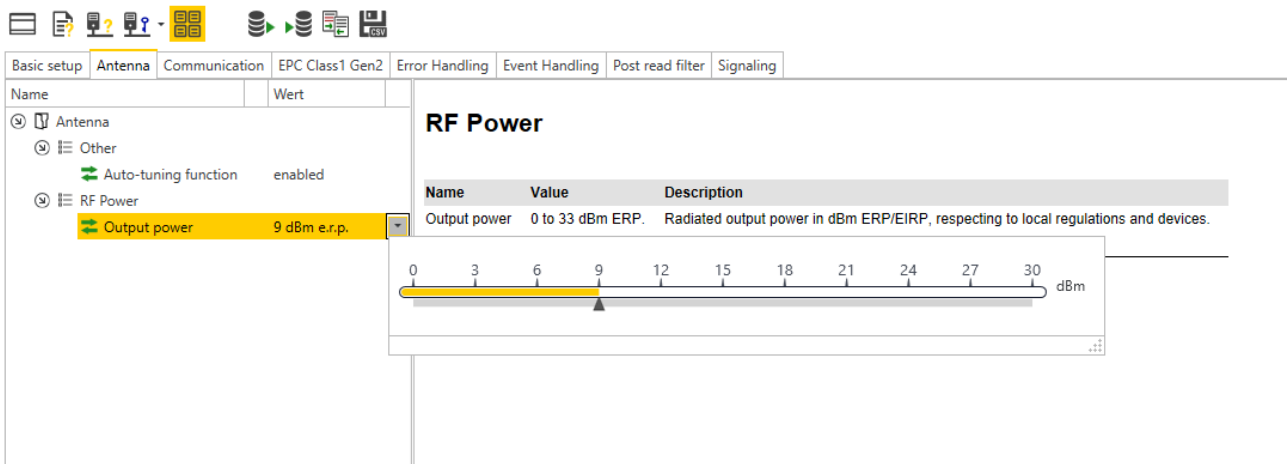

Fig. 20: Setting the radiated power

7.2.5 Switching on Presence sensing mode

In order to use the Continuous presence sensing mode command, the Presence sensing mode must be activated in the read/write head. In Presence sensing mode, the read/write heads are automatically switched on as soon as a tag is located in the detection range.

- ▶ Choose **Basic setup** → **General** → **Device mode** and set the **presence sensing mode** option.

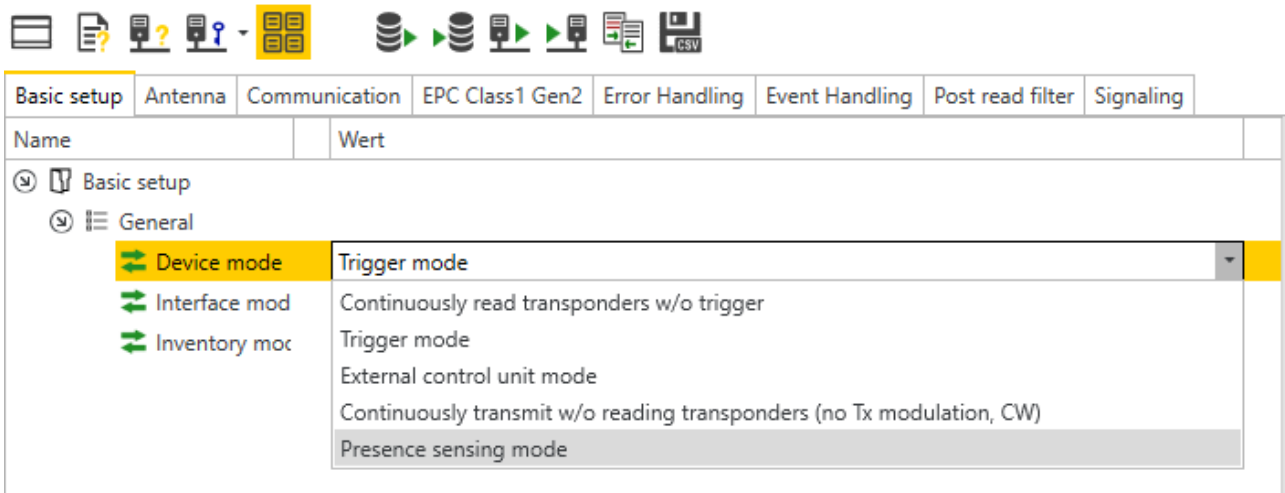

Fig. 21: Switching on Presence sensing mode

The Advanced access level allows the **Tag data delay time** and **Carrier delay time** parameters to be set individually.

- **Tag data delay time:** Time in which the read/write head searches for a tag. If a tag is found, the field is switched on. In the Basic access level, the parameter is set by default to 100 ms.
- **Carrier delay time:** Time until the read/write head switches off the field after the last read operation. In the Basic access level, the parameter is set by default to 65535 ms.



NOTE

Report mode is recommended for the RFID test since the read tag information items appear in the RFID test window and do not have to be polled individually.

7.2.6 Transferring the RSSI value – communication

The **Communication** tab is used to set the parameters for the configuration of the deBus messages. All parameters and the settable values are written in the DTM.

Example: switch on RSSI transmission

- ▶ Switch on RSSI transmission: choose **Communication** → **Message data content** → **Transponder RSSI** and select the **enabled** option.
- ⇒ The RSSI value is displayed with the inventory in the read data.

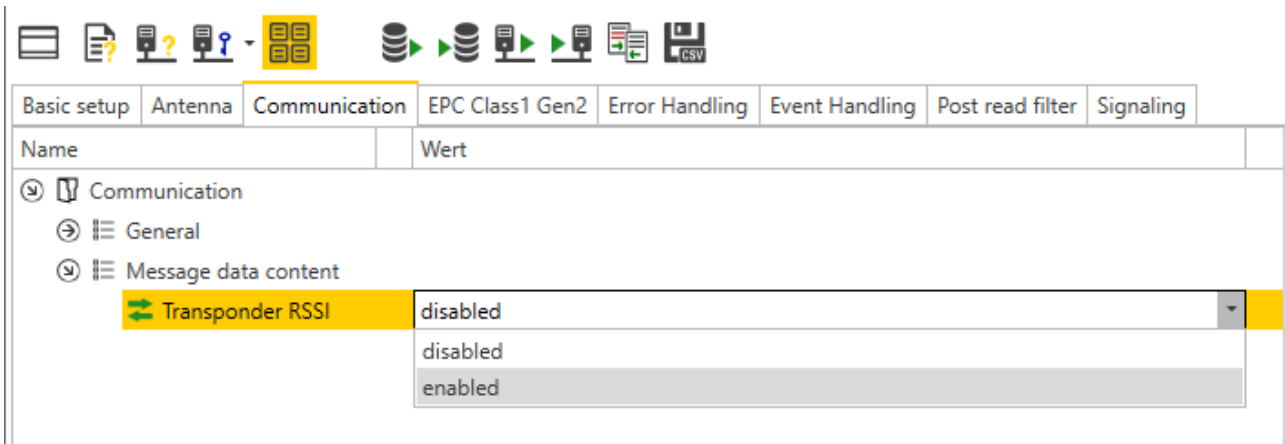

Fig. 22: Switching on RSSI transmission

7.2.7 Setting the air interface parameters – EPC Class 1 Gen 2

The EPC Class1 Gen2 tab is used to set the **EPC Class1 Gen2** parameters for the air interface. The parameters set are used if the read/write head performs an Inventory command. All parameters and the settable values are written in the DTM.

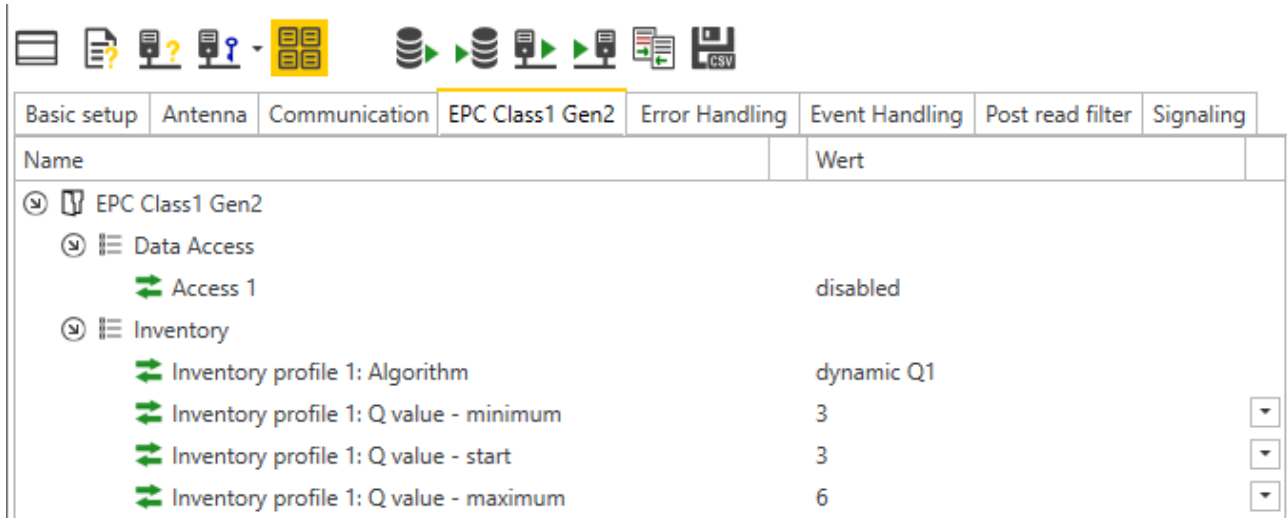

Fig. 23: Setting air interface parameters

7.2.8 Error Handling – selectable parameters

The behavior of the read/write head in response to errors (e.g. LED behavior) can be set in the **Error Handling** tab. All parameters and the settable values are written in the DTM.

7.2.9 Event Handling – selectable parameters

The behavior of the read/write head in response to different events (e.g. LED behavior) can be set in the **Event Handling** tab. All parameters and the settable values are written in the DTM.

7.2.10 Setting the RSSI filter – Post read filter

The **Post read filter** tab enables parameters to be set in order to filter event messages.

The set filters do not reduce the data traffic on the air interface and are not suitable for multi-tag applications with many tags or high passing speeds. All parameters and the settable values are written in the DTM.

Example: set the RSSI filter

An RSSI filter makes it possible to prevent unwanted read operations. All read operations with an RSSI outside of the set limit values are filtered out and not displayed.

- ▶ At **Post read filter** → **RSSI filter** switch on the RSSI filter.

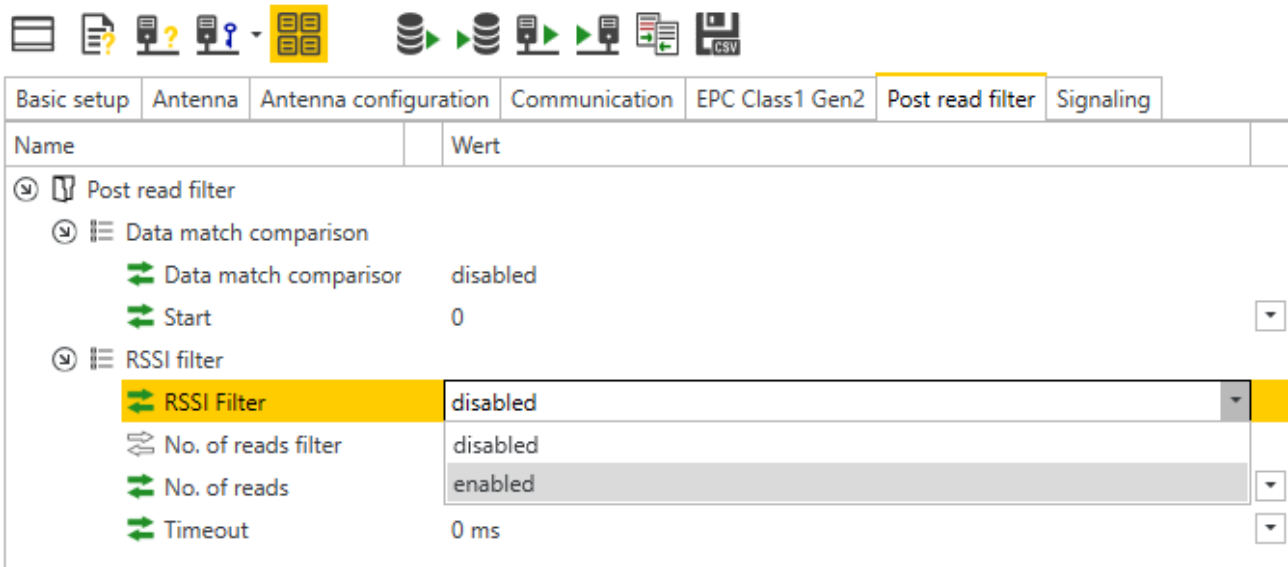

Fig. 24: Switching on the RSSI filter

- ▶ Set the limit values at **Post read filter** → **RSSI filter** → **Lower threshold**.
- ⇒ Example: all read operations below an RSSI value of -45 dBm are filtered out.

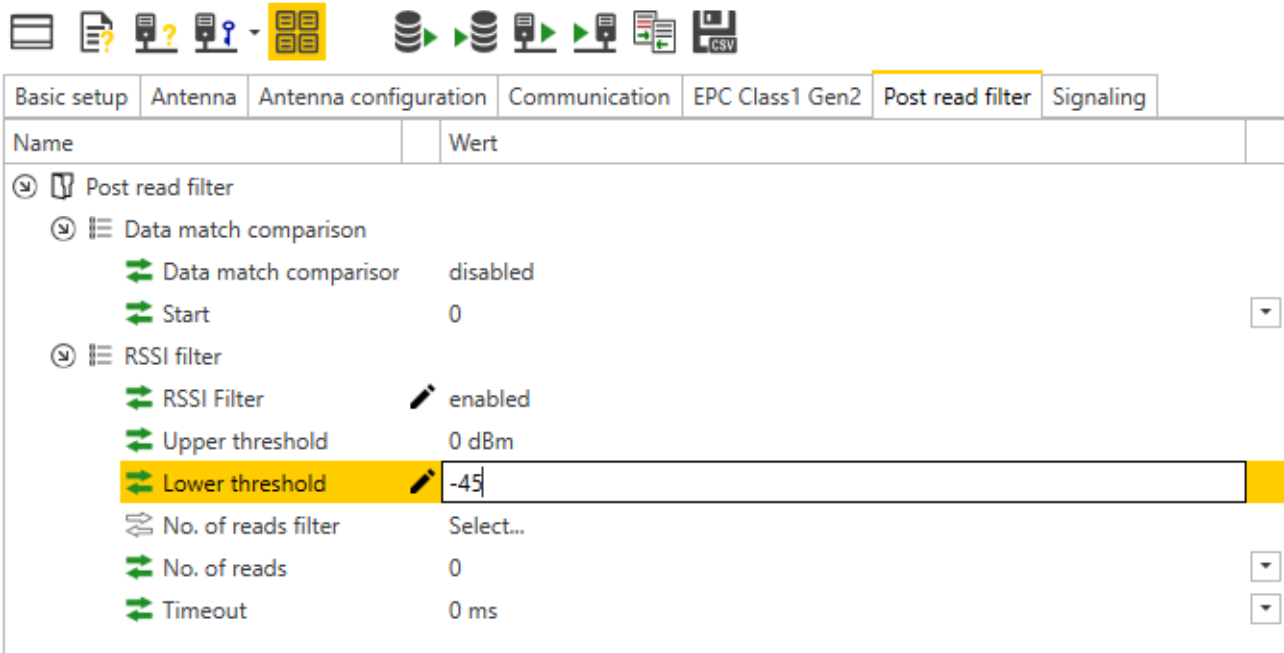

Fig. 25: Example – setting the limit value for RSSI

7.2.11 Setting LED indication – Signaling

The **Signaling** tab enables the default settings for the USER LEDs to be edited. All parameters and the settable values are written in the DTM.

7.3 Testing the read/write head

The following functions can be executed via the RFID Test in the DTM:

- Displaying read data
- Displaying the protocol of the communication between host or PC and read/write head
- Logging of the interface communication between host or PC and read/write head
- Sending of user-specific deBus commands
- Writing of tags with a user-defined number
- Sending tag-specific commands

Requirements for the RFID Test

- PACTware must be installed.
- The DTM for UHF read/write heads must be installed.
- The connection between the read/write head and the PC must be established.
- A project must have been created in PACTware.

7.3.1 Starting the RFID Test

- ▶ Right-click the device in the project tree.
- ▶ In the context menu choose **Additional functions** → **RFID Test**.

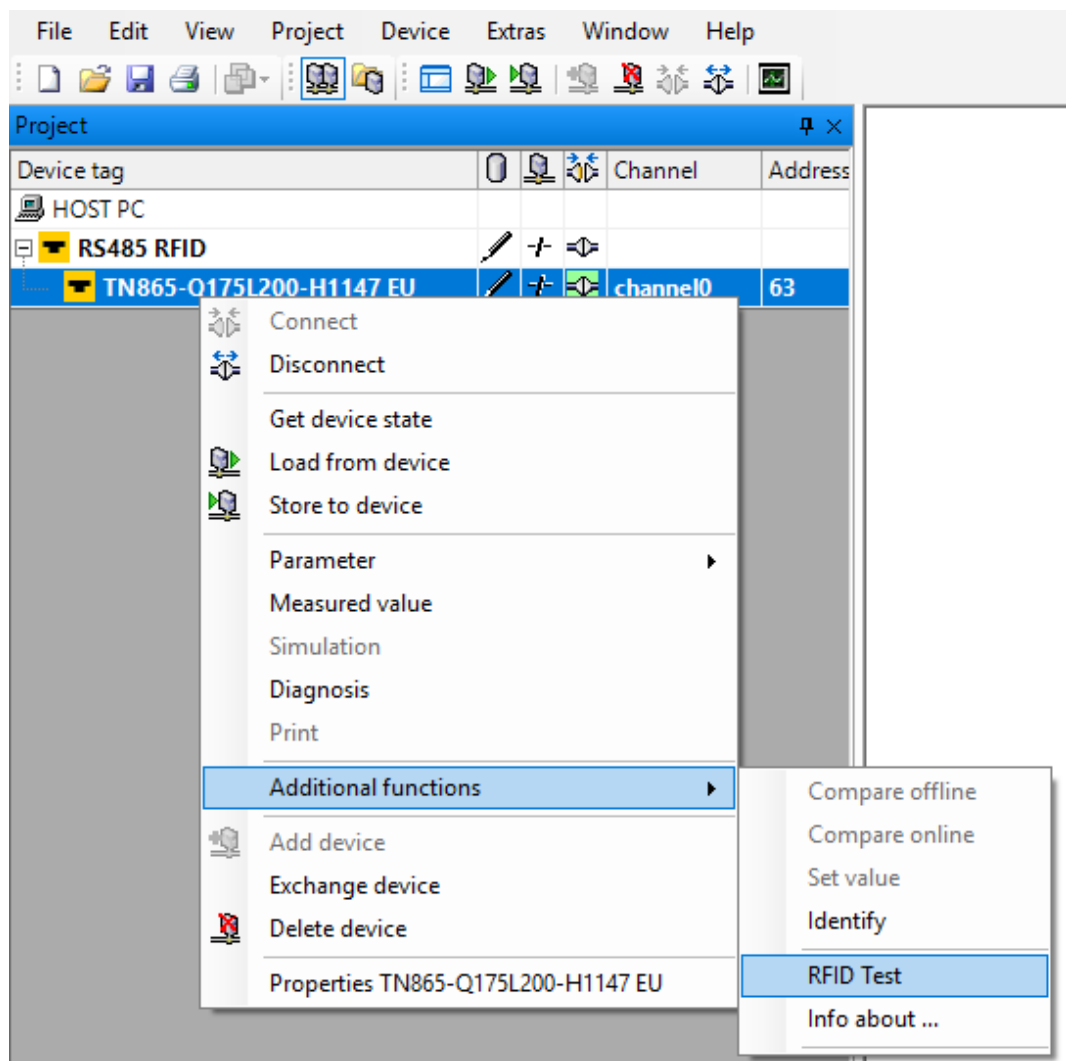

Fig. 26: Starting the RFID Test

7.3.2 Start window – overview

The **RFID Test** window consists of the following elements:

- Main menu
- Basic test
- Tag actions
- Reader Status
- Logger

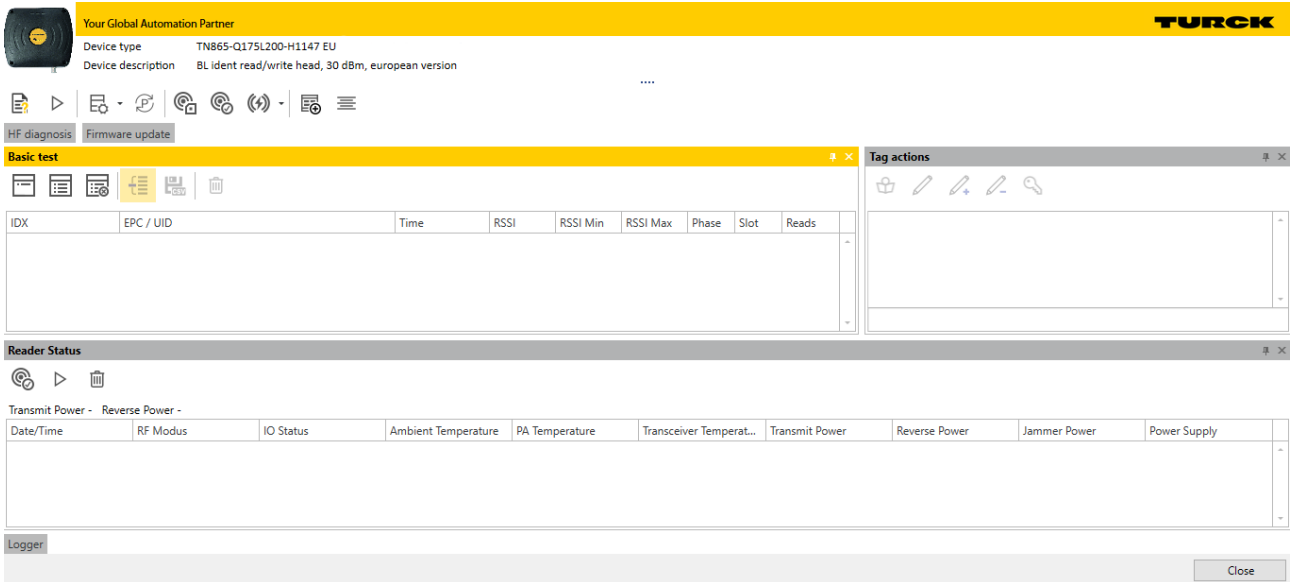

Fig. 27: RFID Test – overview of the start window

7.3.3 RFID Test – main menu



Fig. 28: RFID Test – main menu

The main menu provides the following functions:

Icon	Function	Description
	DTM help	Starts the DTM help.
	Trigger start/ON or Trigger stop/OFF	Starts the trigger for command execution (standard view). Ends the trigger for command execution (displayed after clicking the start button).
	Configure message content	Displays the content to be transferred with a read operation. The following can be selected: <ul style="list-style-type: none"> ■ Phase ■ RSSI ■ Socket ■ Time
	Switch mode (report/polling)	Switches between Report mode (automatic read/write) and polling mode (read/write started through an explicit polling command).
	Get read/write head status	Calls the status of the read/write head and provides the information in the Logger window.
	Get read/write head version	Calls the following information from the read/write head and provides the information in the Logger window: <ul style="list-style-type: none"> ■ Hardware revision ■ Firmware status ■ Serial number
	Reset the read/write head	Offers three ways of resetting the read/write head: <ul style="list-style-type: none"> ■ Voltage reset ■ Factory reset: Reset to factory settings ■ Reset read/write head status <p>When resetting to factory settings, any modified transfer rate or RS485 address is not changed because the read/write head could not otherwise be addressed any longer.</p>
	Set current window layout as default	Saves the individually set window layout.
	Reset window layout	Resets the window layout.
	HF diagnosis	Opens the window for HF diagnostics.
	Firmware update	Opens the window for the firmware update.

7.3.4 RFID Test – Basic test window

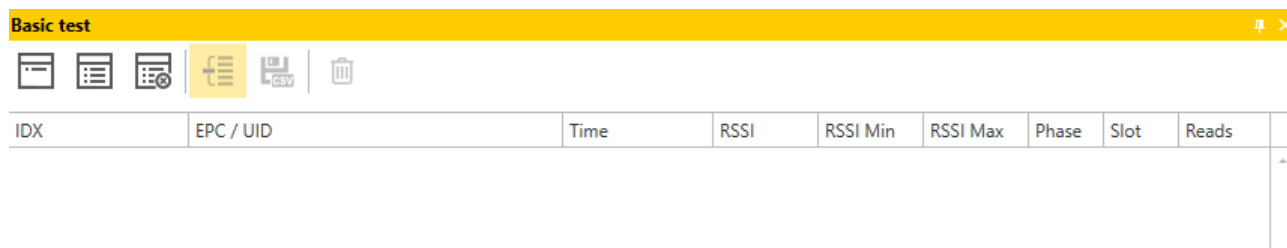

Fig. 29: RFID Test – Basic test window

The following functions are available in the **Basic test** window:

Icon	Function	Description
	Polling	Shows the first tag in the polling memory of the device in the tag list. The function is only available in polling mode.
	Poll all	Shows all tags in the polling memory of the device in the tag list. The function is only available in polling mode.
	Clear polled tags from read/write head	Clears the polling memory of the read/write head.
	Group tag list	Combines readings of tags with the same EPC.
	CSV export current values	Saves the tag list in CSV format.
	Clear tag list	Deletes the list of displayed tags.

The queried data is displayed in the tag list. The content of the message can be set via the **Configure message content** function.



NOTE

If the polling memory of the read/write head is full, the ERR LED is lit red and indicates an internal error.

7.3.5 RFID Test – Tag actions window

The functions in the **Tag actions** window are available if a tag is selected in the tag list of the **Basic test** window.

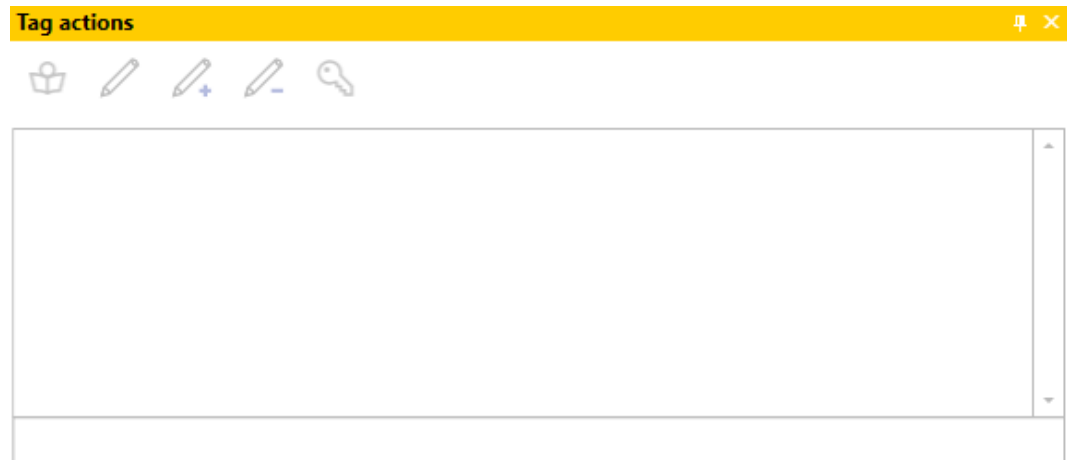







Fig. 30: RFID Test – Tag actions window

The following functions are available in the **Tag actions** window:

Icon	Function	Description
	Read RFID tag memory	Starts the read operation. The chip type is automatically displayed. One word is always read with the first read operation. The following parameters can be set for other read operations: <ul style="list-style-type: none"> Memory bank (TID, EPC/UID, PC, access password or kill password) Start word Number of words The read data is displayed in the Data area.
	Write RFID tag memory	Starts the write operation. The chip type is automatically displayed. The following parameters can be set for the write operations: <ul style="list-style-type: none"> Memory bank (TID, EPC/UID, PC, access password or kill password) Start word Number of words Data to be written is displayed in the Data area.
	Auto-increment	The EPC is incremented automatically by 1.
	Auto-decrement	The EPC is decremented automatically by 1.
	Switch on/off access password	Switches the password for write or read access on or off.

Example: execute tag actions

- ▶ Position tag in detection range of the read/write head.
- ▶ Activate the trigger for the read/write head in the main menu.



Fig. 31: Main menu – activating trigger

- ▶ **Basic test** window: execute polling command in order to display tag in the tag list.
- ▶ **Basic test** window: select tag from the tag list.

IDX	EPC/UID	Time	RSSI	RSSI Min	RSSI Max	Phase	Slot	Reads
1	4242 FB63 AC1F 3841 EC88 0467	08:50:34.695	-40.2	-40.2	-40.2	53	5	1

Fig. 32: Basic test – tag selection





- ▶ **Tag actions** window: To read, select **Memory location**, **Start word** or **Word length** and click the appropriate icon.
- ▶ To write enter values under **Data** and confirm with **OK**

Tag actions	
Manufacturer/Model	Impinj Monza R6
Memory location	EPC / UID
Start word	2
Word length	6
Data	
Status: Tag detected	

Fig. 33: Execute tag action (example: read)

⇒ Successful access is displayed via the status message at the bottom of the window.

Tag actions ⌵ ✕

Manufacturer/Model	Impinj Monza R6
Memory location	TID memory
Start word	0
Word length	6
Data	E2801160200065EE1F0A092A

Status: Read successful

Fig. 34: Example: read successful

7.3.6 RFID Test – Logger window

The **Logger** window displays read/write information and error messages. The list can be cleared via the **Delete** button.

Logger





Date/Time	Type	Message
 2020-06-22 13:56:29.351	Error	Communication timeout (Command: 255)
 2020-06-22 13:56:29.359	Error	Communication timeout (Command: 255)
 2020-06-22 13:56:29.363	Error	Communication timeout (Command: 255)

Fig. 35: Messages in the Logger window

7.3.7 RFID Test – Reader Status window

The **Reader Status** window displays the following parameters:

- Ambient temperature: Temperature inside the read/write head
- PA temperature: Temperature of the power amplifier
- Transceiver temperature: Temperature of the read/write head chip
- Transmit power: Effective radiated power (ERP)
- Reverse power: The power radiated back to the electronics

Date/Time	RF Modus	IO Status	Ambient Temperature	PA Temperature	Transceiver Temperature	Transmit Power	Reverse Power	Jammer Power
2020-01-28 10:05:35.350	None	00000000 [0x00]	27 C°	25 C°	27 C°	0 dBm	-14,4 dBm	0 dBm
2020-01-28 10:05:37.346	None	00000000 [0x00]	27 C°	25 C°	27 C°	0 dBm	-14,4 dBm	0 dBm
2020-01-28 10:05:39.347	None	00000000 [0x00]	27 C°	25 C°	27 C°	0 dBm	-14,4 dBm	0 dBm
2020-01-28 10:05:41.380	None	00000000 [0x00]	27 C°	25 C°	27 C°	0 dBm	-14,4 dBm	0 dBm
2020-01-28 10:05:47.463	Manual	00000000 [0x00]	27 C°	25 C°	27 C°	0 dBm	-14,4 dBm	0 dBm
2020-01-28 10:05:54.645	None	00000000 [0x00]	27 C°	31 C°	29 C°	29,8 dBm	-9,1 dBm	-27,6 dBm
2020-01-28 10:07:31.952	Manual	00000000 [0x00]	27 C°	25 C°	27 C°	0 dBm	-14,4 dBm	0 dBm
2020-01-28 10:08:06.426	None	00000000 [0x00]	27 C°	31 C°	33 C°	30 dBm	-9,1 dBm	-20,7 dBm

Fig. 36: Messages in the Reader Status window

The list can be cleared via the **Delete** button.

7.3.8 HF diagnosis window

Interference frequencies affecting the respective channels are displayed in the **HF diagnosis** window.

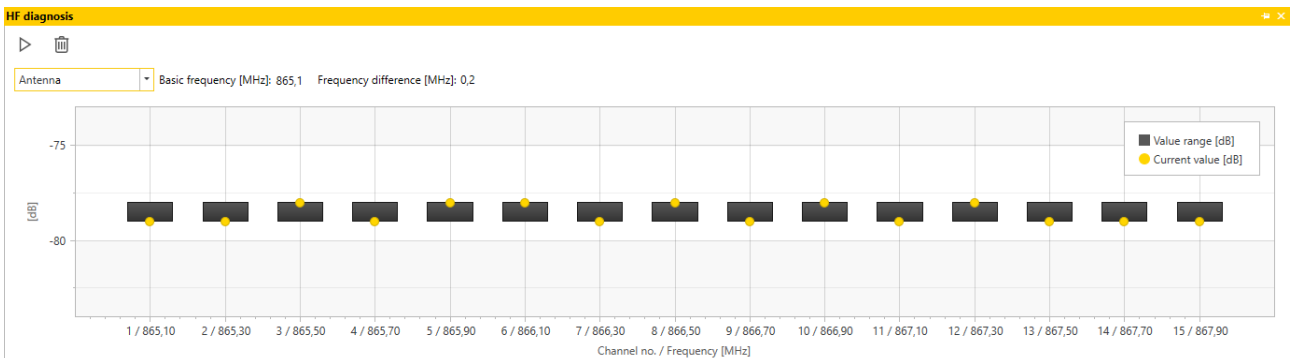

Fig. 37: HF diagnosis window

The following functions can be executed in the **HF diagnosis** window:

Icon	Function	Description
	Start/stop HF diagnosis	Starts or closes the HF diagnosis.
	Clear values	Deletes the displayed values.

7.4 Querying device information with the DTM

The DTM provides access to hardware and software information as well as regulations on the connected device.

- ▶ Right-click the device in the project tree.
- ▶ Choose **Additional functions** → **Identify**.

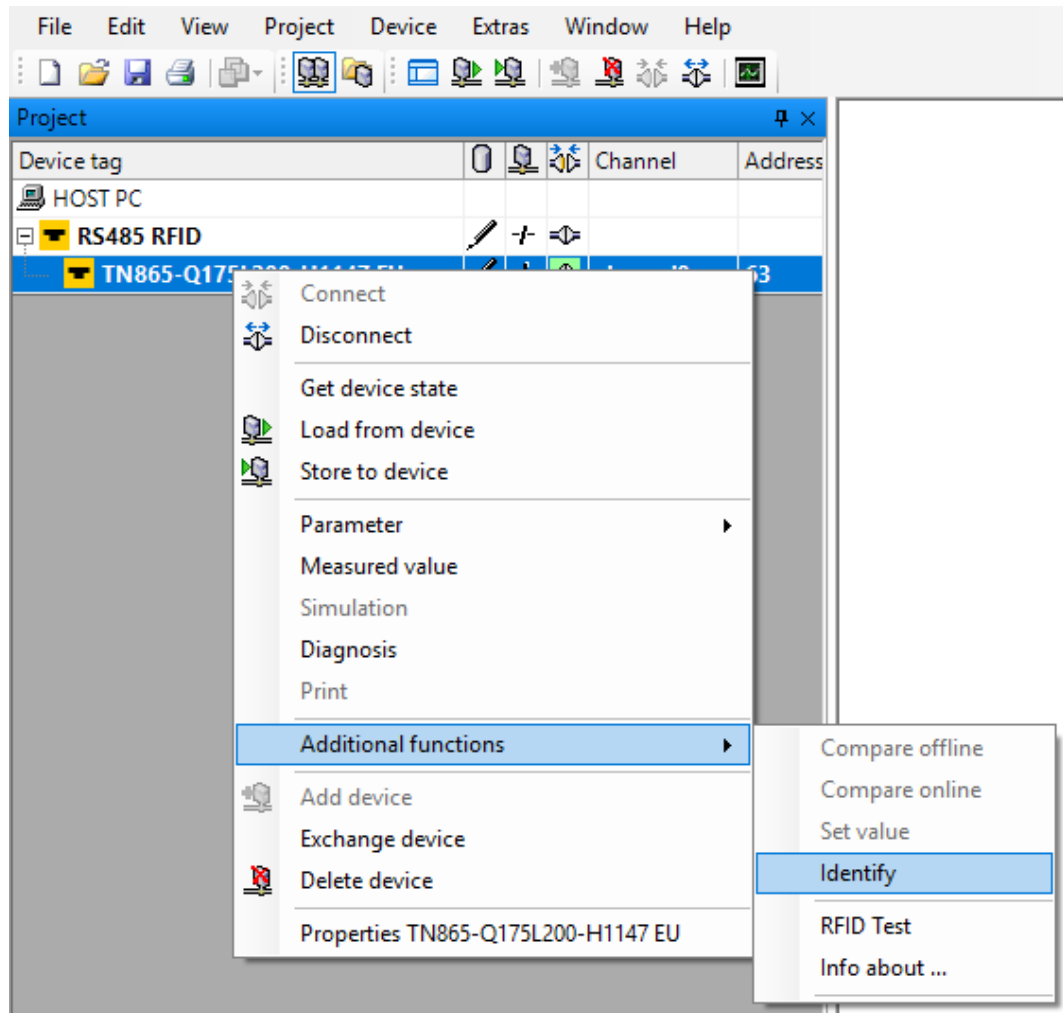

Fig. 38: Calling up Identification

⇒ The DTM shows the available information on the device according to the selected access level.

⊙	📄	Device information	
⊙	☰	Hardware	
	🔍	Device type	Q175L200
	🔍	Internal antenna	available
	🔍	RS485 termination on/off switch	available
	🔍	Serial number	212101439
	🔍	Transceiver ASIC	R2000
	🔍	Prefix customer ID	1000001 (hex)
⊙	☰	Software	
	🔍	Firmware version	01.56
⊙	☰	Regulations	
	🔍	Adaptive frequency agility	available
	🔍	Fixed frequency	available
	🔍	Frequency hopping	available
	🔍	Listen before talk	not available
	🔍	Number of available channels	15
⊙	☰	Regulations: Channel mask	
	🔍	Channel mask: Channel 1	-
	🔍	Channel mask: Channel 2	-
	🔍	Channel mask: Channel 3	-
	🔍	Channel mask: Channel 4	enabled
	🔍	Channel mask: Channel 5	-

Fig. 39: Device information for TN865-Q175L200-H1147 in the Advanced access level

8 Operation

8.1 LED indications

The devices are provided with three LEDs for displaying the status of the device. The indication functions can be adjusted for the specific application via the DTM.

The LEDs are factory set with the following indication functions after a voltage reset:

LED	State	Meaning
1 (operating state)	Off	No operating voltage
	Green	Operating voltage connected
	Off 0.2 s	Tag detected
2 (state of the wireless field)	Off	Wireless field deactivated
	Yellow	Wireless field activated
3 (errors)	Off	No internal error
	Red	Internal error detected

9 Troubleshooting

If the device does not work as expected, proceed as follows:

- ▶ Exclude environmental disturbances.
- ▶ Check the connections of the device for errors.
- ▶ Check device for parameterization errors.

If the malfunction persists, the device is faulty. In this case, decommission the device and replace it with a new device of the same type.

9.1 Rectifying errors

Errors are displayed by an ERR LED lit red on the device.

Calling error messages in the DTM and rectifying them



NOTE

Contact Turck if the error persists after the read/write head is reset.

- ▶ Right-click the device in the project tree.
- ▶ Select **Diagnosis** in the context menu.

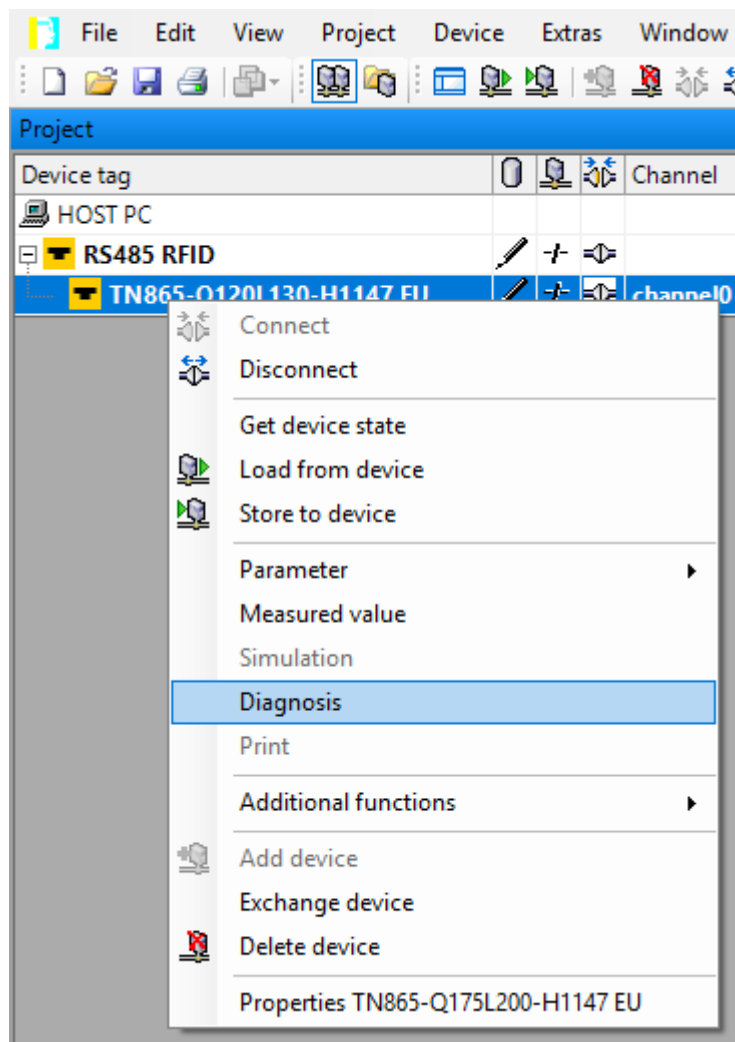

Fig. 40: Project tree – starting diagnosis

⇒ The diagnosis window opens in the DTM.

The screenshot shows the DTM interface with the diagnosis window open. The left pane lists error messages, with 'Temperature too high' highlighted. The right pane displays a detailed table of device status.

Name	Value	Description
Configuration invalid / Operation impossible	-	The current configuration is valid.
Configuration invalid / Operation impossible	active	The current configuration is invalid. The device will not operate unless the configuration has been corrected.
Message generation error - out of memory in polling mode	-	No message generation error and the polling buffer is not out of memory.
Message generation error - out of memory in polling mode	active	The polling buffer is out of memory. No further messages can be generated, no further tag can be read.
RF Transceiver communication error	-	No RF read/write head communication error.
RF Transceiver communication error	active	An internal communication error has occurred. Contact support if this error still occurs after resetting the device.
Temperature too high	-	Internal temperature ok.
Temperature too high	active	The internal temperature is out of range and the device will not operate.
Temperature warning	-	Internal temperature within allowed range.
Temperature warning	active	The internal temperature is close to going out of range. The device will stop to operate if the temperature is out of range.

Fig. 41: DTM – diagnosis

Rectifying error messages:

- ▶ Click the **Reset read/write head** button in the RFID Test main menu.
- ▶ Select **Reset the read/write head** in the drop-down menu.
- ⇒ The read/write head is reset.

The screenshot shows the DTM main menu. The 'Basic test' section is active, and a dropdown menu is open, highlighting the 'Reset the read/write head' option with a red box.

IDX	EPC / UID	Time	RSSI	RSSI Min	RSSI Max	Phase	Slot	Reads
-----	-----------	------	------	----------	----------	-------	------	-------

Fig. 42: DTM – Reset the read/write head

10 Maintenance

Ensure that the plug connections and cables are always in good condition.

The devices are maintenance-free, clean dry if required.

11 Repair

The device must not be repaired by the user. The device must be decommissioned if it is faulty. Observe our return acceptance conditions when returning the device to Turck.

11.1 Returning devices

Returns to Turck can only be accepted if the device has been equipped with a Decontamination declaration enclosed. The decontamination declaration can be downloaded from <https://www.turck.de/en/retoure-service-6079.php> and must be completely filled in, and affixed securely and weather-proof to the outside of the packaging.

12 Disposal



The devices must be disposed of correctly and must not be included in general household garbage.

13 Technical Data

13.1 Technical data – TN865...

Technical data	TN865-Q120...	TN865-Q175...
Mounting condition	Non-flush	Non-flush
Ambient temperature	-25...+50 °C	-25...+50 °C
Operating voltage	12...24 VDC	12...24 VDC
Data transmission	Electromagnetic AC field	Electromagnetic AC field
Operating frequency	865...868 MHz	865...868 MHz
Wireless communication and protocol standards	ISO 18000-6C EN 302208 EPCglobal Gen 2	ISO 18000-6C EN 302208 EPCglobal Gen 2
Channel distance	200/600 kHz	200/600 kHz
Output power	0.5 W (ERP), adjustable	1 W (ERP), adjustable
Antenna polarization	Clockwise	Clockwise
Antenna half power beam width	110°	90°
Read-write distance max.	1500 mm	4000 mm
Output function	4-wire, read/write	4-wire, read/write
Design	Rectangular	Rectangular
Dimensions	130 × 120 × 60 mm	200 × 175 × 60 mm
Housing material	Aluminum, AL, silver	Aluminum, AL, silver
Material of active face	Plastic, ABS, black	Plastic, ABS, black
Electrical connection	Male connector, M12 x 1	Male connector, M12 x 1
Vibration resistance	55 Hz (1 mm)	55 Hz (1 mm)
Shock resistance	30 g (11 ms)	30 g (11 ms)
Type of protection	IP67	IP67
MTTF	51 years acc. to SN 29500 (Ed. 99) 40°C	51 years acc. to SN 29500 (Ed. 99) 40°C

13.2 Technical data – TN902...

Technical data	TN902-Q120...	TN902-Q175...
Mounting condition	Non-flush	Non-flush
Ambient temperature	-25...+50 °C	-25...+50 °C
Operating voltage	12...24 VDC	12...24 VDC
Data transmission	Electromagnetic AC field	Electromagnetic AC field
Operating frequency	902...928 MHz	902...928 MHz
Wireless communication and protocol standards	ISO 18000-6C EPCglobal Gen 2	ISO 18000-6C EPCglobal Gen 2
Channel distance	500 kHz	500 kHz
Output power	0.5 W (ERP), adjustable	1 W (ERP), adjustable
Antenna polarization	Clockwise	Clockwise
Antenna half power beam width	110°	90°
Read-write distance max.	1500 mm	4000 mm
Output function	4-wire, read/write	4-wire, read/write
Design	Rectangular	Rectangular
Dimensions	130 × 120 × 60 mm	200 × 175 × 60 mm
Housing material	Aluminum, AL, silver	Aluminum, AL, silver
Material of active face	Plastic, ABS, black	Plastic, ABS, black
Electrical connection	Male connector, M12 x 1	Male connector, M12 x 1
Vibration resistance	55 Hz (1 mm)	55 Hz (1 mm)
Shock resistance	30 g (11 ms)	30 g (11 ms)
Type of protection	IP67	IP67
MTTF	51 years acc. to SN 29500 (Ed. 99) 40°C	51 years acc. to SN 29500 (Ed. 99) 40°C

13.3 Technical data – TN840/920...

Technical data	TN840/920-Q120...	TN840/920-Q175...
Mounting condition	Non-flush	Non-flush
Ambient temperature	-25...+50 °C	-25...+50 °C
Operating voltage	12...24 VDC	12...24 VDC
Data transmission	Electromagnetic AC field	Electromagnetic AC field
Operating frequency	920...925 MHz	920...925 MHz
Wireless communication and protocol standards	ISO 18000-6C EPCglobal Gen 2	ISO 18000-6C EPCglobal Gen 2
Channel distance	250 kHz	250 kHz
Output power	0.5 W (ERP), adjustable	1 W (ERP), adjustable
Antenna polarization	Clockwise	Clockwise
Antenna half power beam width	110°	90°
Read-write distance max.	1500 mm	4000 mm
Output function	4-wire, read/write	4-wire, read/write
Design	Rectangular	Rectangular
Dimensions	130 × 120 × 60 mm	200 × 175 × 60 mm
Housing material	Aluminum, AL, silver	Aluminum, AL, silver
Material of active face	Plastic, ABS, black	Plastic, ABS, black
Electrical connection	Male connector, M12 x 1	Male connector, M12 x 1
Vibration resistance	55 Hz (1 mm)	55 Hz (1 mm)
Shock resistance	30 g (11 ms)	30 g (11 ms)
Type of protection	IP67	IP67
MTTF	51 years acc. to SN 29500 (Ed. 99) 40°C	51 years acc. to SN 29500 (Ed. 99) 40°C

13.4 Technical data – TN917...

Technical data	TN917-Q120...	TN917-Q175...
Mounting condition	Non-flush	Non-flush
Ambient temperature	-25...+50 °C	-25...+50 °C
Operating voltage	12...24 VDC	12...24 VDC
Data transmission	Electromagnetic AC field	Electromagnetic AC field
Operating frequency	917...920.8 MHz	917...920.8 MHz
Wireless communication and protocol standards	ISO 18000-6C EPCglobal Gen 2	ISO 18000-6C EPCglobal Gen 2
Channel distance	600 kHz	600 kHz
Output power	0.5 W (ERP), adjustable	1 W (ERP), adjustable
Antenna polarization	Clockwise	Clockwise
Antenna half power beam width	110°	90°
Read-write distance max.	1500 mm	4000 mm
Output function	4-wire, read/write	4-wire, read/write
Design	Rectangular	Rectangular
Dimensions	130 × 120 × 60 mm	200 × 175 × 60 mm
Housing material	Aluminum, AL, silver	Aluminum, AL, silver
Material of active face	Plastic, ABS, black	Plastic, ABS, black
Electrical connection	Male connector, M12 x 1	Male connector, M12 x 1
Vibration resistance	55 Hz (1 mm)	55 Hz (1 mm)
Shock resistance	30 g (11 ms)	30 g (11 ms)
Type of protection	IP67	IP67
MTTF	51 years acc. to SN 29500 (Ed. 99) 40°C	51 years acc. to SN 29500 (Ed. 99) 40°C

13.5 Technical data – TN866...

Technical data	TN866-Q120...	TN866-Q175...
Mounting condition	Non-flush	Non-flush
Ambient temperature	-25...+50 °C	-25...+50 °C
Operating voltage	12...24 VDC	12...24 VDC
Data transmission	Electromagnetic AC field	Electromagnetic AC field
Operating frequency	866...868 MHz	866...868 MHz
Wireless communication and protocol standards	ISO 18000-6C EPCglobal Gen 2	ISO 18000-6C EPCglobal Gen 2
Channel distance	200 kHz	200 kHz
Output power	0.5 W (ERP), adjustable	1 W (ERP), adjustable
Antenna polarization	Clockwise	Clockwise
Antenna half power beam width	110°	90°
Read-write distance max.	1500 mm	4000 mm
Output function	4-wire, read/write	4-wire, read/write
Design	Rectangular	Rectangular
Dimensions	130 × 120 × 60 mm	200 × 175 × 60 mm
Housing material	Aluminum, AL, silver	Aluminum, AL, silver
Material of active face	Plastic, ABS, black	Plastic, ABS, black
Electrical connection	Male connector, M12 x 1	Male connector, M12 x 1
Vibration resistance	55 Hz (1 mm)	55 Hz (1 mm)
Shock resistance	30 g (11 ms)	30 g (11 ms)
Type of protection	IP67	IP67
MTTF	51 years acc. to SN 29500 (Ed. 99) 40°C	51 years acc. to SN 29500 (Ed. 99) 40°C

13.6 Technical data – TN902/915...

Technical data	TN902/915-Q120...	TN902/915-Q175...
Mounting condition	Non-flush	Non-flush
Ambient temperature	-25...+50 °C	-25...+50 °C
Operating voltage	12...24 VDC	12...24 VDC
Data transmission	Electromagnetic AC field	Electromagnetic AC field
Operating frequency	915...928 MHz	915...928 MHz
Wireless communication and protocol standards	ISO 18000-6C EPCglobal Gen 2	ISO 18000-6C EPCglobal Gen 2
Channel distance	250 kHz	250 kHz
Output power	0.5 W (ERP), adjustable	1 W (ERP), adjustable
Antenna polarization	Clockwise	Clockwise
Antenna half power beam width	110°	90°
Read-write distance max.	1500 mm	4000 mm
Output function	4-wire, read/write	4-wire, read/write
Design	Rectangular	Rectangular
Dimensions	130 × 120 × 60 mm	200 × 175 × 60 mm
Housing material	Aluminum, AL, silver	Aluminum, AL, silver
Material of active face	Plastic, ABS, black	Plastic, ABS, black
Electrical connection	Male connector, M12 x 1	Male connector, M12 x 1
Vibration resistance	55 Hz (1 mm)	55 Hz (1 mm)
Shock resistance	30 g (11 ms)	30 g (11 ms)
Type of protection	IP67	IP67
MTTF	51 years acc. to SN 29500 (Ed. 99) 40°C	51 years acc. to SN 29500 (Ed. 99) 40°C

13.7 Technical data – TN920...

Technical data	TN920-Q120...	TN920-Q175...
Mounting condition	Non-flush	Non-flush
Ambient temperature	-25...+50 °C	-25...+50 °C
Operating voltage	12...24 VDC	12...24 VDC
Data transmission	Electromagnetic AC field	Electromagnetic AC field
Operating frequency	920...926 MHz	920...926 MHz
Wireless communication and protocol standards	ISO 18000-6C EPCglobal Gen 2	ISO 18000-6C EPCglobal Gen 2
Channel distance	500 kHz	500 kHz
Output power	0.5 W (ERP), adjustable	1 W (ERP), adjustable
Antenna polarization	Clockwise	Clockwise
Antenna half power beam width	110°	90°
Read-write distance max.	1500 mm	4000 mm
Output function	4-wire, read/write	4-wire, read/write
Design	Rectangular	Rectangular
Dimensions	130 × 120 × 60 mm	200 × 175 × 60 mm
Housing material	Aluminum, AL, silver	Aluminum, AL, silver
Material of active face	Plastic, ABS, black	Plastic, ABS, black
Electrical connection	Male connector, M12 x 1	Male connector, M12 x 1
Vibration resistance	55 Hz (1 mm)	55 Hz (1 mm)
Shock resistance	30 g (11 ms)	30 g (11 ms)
Type of protection	IP67	IP67
MTTF	51 years acc. to SN 29500 (Ed. 99) 40°C	51 years acc. to SN 29500 (Ed. 99) 40°C

13.8 Technical data – TN921...

Technical data	TN921-Q120...	TN921-Q175...
Mounting condition	Non-flush	Non-flush
Ambient temperature	-25...+50 °C	-25...+50 °C
Operating voltage	12...24 VDC	12...24 VDC
Data transmission	Electromagnetic AC field	Electromagnetic AC field
Operating frequency	920...925 MHz	920...925 MHz
Wireless communication and protocol standards	ISO 18000-6C EPCglobal Gen 2	ISO 18000-6C EPCglobal Gen 2
Channel distance	500 kHz	500 kHz
Output power	0.5 W (ERP), adjustable	1 W (ERP), adjustable The max. output power of the devices is currently limited to 0.5 W ERP due to licensing.
Antenna polarization	Clockwise	Clockwise
Antenna half power beam width	110°	90°
Read-write distance max.	1500 mm	4000 mm
Output function	4-wire, read/write	4-wire, read/write
Design	Rectangular	Rectangular
Dimensions	130 × 120 × 60 mm	200 × 175 × 60 mm
Housing material	Aluminum, AL, silver	Aluminum, AL, silver
Material of active face	Plastic, ABS, black	Plastic, ABS, black
Electrical connection	Male connector, M12 x 1	Male connector, M12 x 1
Vibration resistance	55 Hz (1 mm)	55 Hz (1 mm)
Shock resistance	30 g (11 ms)	30 g (11 ms)
Type of protection	IP67	IP67
MTTF	51 years acc. to SN 29500 (Ed. 99) 40°C	51 years acc. to SN 29500 (Ed. 99) 40°C

14 Appendix: Conformity Declarations and Approvals

14.1 EU Declaration of Conformity

Hans Turck GmbH & Co. KG hereby declares that the TN-865-... wireless system complies with directive 2014/53/EU. The complete text of the EU declaration of conformity can be obtained from the following Internet address: www.turck.com.

14.2 FCC/IC digital device limitations – TN902-Q120L130-H1147

FCC ID: YQ7TN902-Q120L131

IC ID: 8821A-T902Q12L14

This device complies with Part 15 of the FCC Rules and Industry Canada license-exempt RSS standard(s). Operation is subject to the following two conditions:

- (1) this device may not cause harmful interference, and
- (2) this device must accept any interference received, including interference that may cause undesired operation.

Changes or modifications not expressly approved by the party responsible for compliance could void the user's authority to operate the equipment.

Le présent appareil est conforme aux CNR d'Industrie Canada applicables aux appareils radio exempts de licence. L'exploitation est autorisée aux deux conditions suivantes :

- (1) l'appareil ne doit pas produire de brouillage, et
- (2) l'utilisateur de l'appareil doit accepter tout brouillage radioélectrique subi, même si le brouillage est susceptible d'en compromettre le fonctionnement.

Note: This equipment has been tested and found to comply with the limits for a Class A digital device, pursuant to part 15 of the FCC Rules. These limits are designed to provide reasonable protection against harmful interference when the equipment is operated in a commercial environment.

This equipment generates, uses, and can radiate radio frequency energy and, if not installed and used in accordance with the instruction manual, may cause harmful interference to radio communications. Operation of this equipment in a residential area is likely to cause harmful interference in which case the user will be required to correct the interference at his own expense.

This equipment complies with FCC/IC exposure limits set forth for an uncontrolled environment.

This equipment should be installed and operated with minimum distance 30 cm between the radiator & your body.

CAN ICES-3 (A)/NMB-3(A)

Use only with listed LPS or class 2 power supply!

14.3 FCC/IC digital device limitations – TN902-Q175L200-H1147

FCC ID: YQ7TN902-Q175L201

IC: 8821A-T902Q17L21

This device complies with Part 15 of the FCC Rules and Industry Canada license-exempt RSS standard(s). Operation is subject to the following two conditions:

- (1) this device may not cause harmful interference, and
- (2) this device must accept any interference received, including interference that may cause undesired operation.

Changes or modifications not expressly approved by the party responsible for compliance could void the user's authority to operate the equipment.

This device complies with Industry Canada licence-exempt RSS standard(s). Operation is subject to the following two conditions:

- (1) this device may not cause interference, and
- (2) this device must accept any interference, including interference that may cause undesired operation of the device.

Le présent appareil est conforme aux CNR d'Industrie Canada applicables aux appareils radio exempts de licence. L'exploitation est autorisée aux deux conditions suivantes :

- (1) l'appareil ne doit pas produire de brouillage, et
- (2) l'utilisateur de l'appareil doit accepter tout brouillage radioélectrique subi, même si le brouillage est susceptible d'en compromettre le fonctionnement.

Note: This equipment has been tested and found to comply with the limits for a Class A digital device, pursuant to part 15 of the FCC Rules.

These limits are designed to provide reasonable protection against harmful interference when the equipment is operated in a commercial environment.

This equipment generates, uses, and can radiate radio frequency energy and, if not installed and used in accordance with the instruction manual, may cause harmful interference to radio communications. Operation of this equipment in a residential area is likely to cause harmful interference in which case the user will be required to correct the interference at his own expense.

This equipment complies with FCC/IC exposure limits set forth for an uncontrolled environment.

This equipment should be installed and operated with minimum distance 30 cm between the radiator & your body.

CAN ICES-3 (A)/NMB-3(A)

Use only with listed LPS or class 2 power supply!

TURCK

Over 30 subsidiaries and over
60 representations worldwide!

100000797 | 2020/08



www.turck.com